

EST-1770 N-1C1671 4
MR HOWARD ERICKSON
BOX 94
BARK RIVER MICH 49807

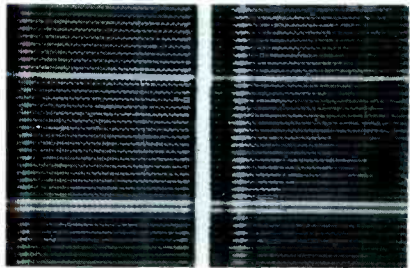

Electronic Servicing

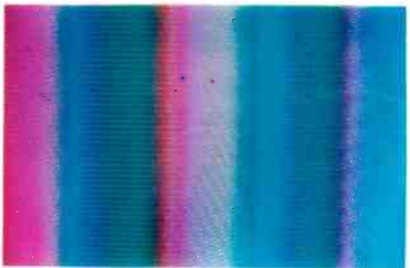
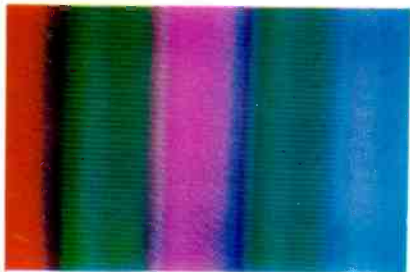

**Using Color-Bar
and Crosshatch Patterns to Evaluate Color TV**
page 26

**Shop Management:
Double-Entry Bookkeeping Simplified**
page 22

simulated picture



It takes time
to replace a color picture tube...

GE ULTRACOLOR[®]

works to cut back
the need of
replacing the
replacement

sustained brightness and color purity are assured through use of advanced getter material. Gases generated by the tube's operation are removed, providing longer life and sustained color purity.

reliability and quality assurance are built in. Only the highest quality replacement components are used... and they're still expected to prove themselves. First during the manufacturing process, through continuing in-line inspections, and extensive life testing of the finished product, afterwards.

GE ULTRACOLOR[®] picture tubes provide the service and dependability that guarantee customer satisfaction. *(Made by professionals, for professionals.)*

TUBE PRODUCTS DEPARTMENT • GENERAL ELECTRIC COMPANY

OWENSBORO, KENTUCKY 42301

GENERAL  ELECTRIC

“We’ve set up our own cross reference system in the Yellow Pages.”

“I have three businesses; selling Appliances, repairing Appliances and Electrical Contracting. The way I’ve listed myself under various headings, I get customers interested in any one of my three businesses,” explains Mr. Worth Warne, owner of Warne Appliance and Electric Service, Seattle, Washington. “I’ve been advertising in the Yellow Pages since about 1938. I personally go to the Yellow Pages when I need something, and I feel other people must do the same thing. It’s quick, it’s easy, items are listed alphabetically, and I can almost always find what I want. The Yellow



Pages is one of the best attention getters in town, and it keeps old and new business coming through the doors.”

Let the Yellow Pages do your talking. People will listen.



An effective way to build business.

Electronic Servicing

in this issue...

SHOP MANAGEMENT

22 Double-Entry Bookkeeping Simplified—What Debit and Credit entries are and how they establish a "balanced" bookkeeping system (**Better Management Guides/Robert G. Amick**).

40 Tube Usage In 1970—A list of tubes used most during the previous year, based on estimates by General Electric.

COLOR TV

26 Using Color-Bar and Crosshatch Patterns to Evaluate Color TV Performance—What keyed color generator patterns reveal about the functioning of the "b-w" and color sections of a receiver (**Troubleshooter/Carl Babcoke**).

AUTO ELECTRONICS

30 Troubleshooting Motor Circuits In Auto Tape Players—Common defects that affect the speed of presently used drive systems and how to detect them, plus speed tests and adjustments (**Carr Electronics/Joseph J. Carr**).

SERVICE ASSOCIATION ACTIVITIES

42 National Electronic Associations' Annual Convention Agenda—Dates and times of meetings, seminars and other activities scheduled for NEA's convention in Portland, Oregon, July 12-18.

TELEVISION (GENERAL)

44 How Circuit Defects Affect Video Waveforms—Analysis of normal and abnormal key waveforms (**Shop Talk/Carl Babcoke**).

HOME AUDIO

54 Stereo FM Tuner Performance Evaluation and Adjustments—Specifications and related test and alignment procedures, plus general adjustments techniques (**Leonard Feldman**).

DEPARTMENTS

Electronic Scanner	4	Antenna Systems Report...	52
Readers' Exchange	12	Book Review	61
Letters to the Editor	18	Product Report	62
Test Equipment Report	37	Advertisers' Index	63
Readers' Service Card	49	Catalog and Literature	64

Second class postage paid at Kansas City, Mo. and additional mailing offices. Published monthly by INTERTEC PUBLISHING CORP., 1014 Wyandotte St., Kansas City, Mo. 64105. Vol. 21, No. 6. Subscription rates \$5 per year in U.S., its possessions and Canada; other countries \$6 per year.

Copyright, 1971, Howard W. Sams & Co., Inc. All rights Reserved. Material may not be reproduced or photocopied in any form without written permission of publisher.

EDITORIAL
GEO. H. SEFEROVICH, Director
J. W. PHIPPS, Managing Editor
CARL BABCOKE, Technical Editor
BARBARA L. BORDERS, Editorial Assistant
DUDLEY ROSE, Art Director

CONTRIBUTING AUTHORS
Bruce Anderson
Joseph J. Carr

TECHNICAL CONSULTANT
JOE A. GROVES

EDITORIAL ADVISORY BOARD
LES NELSON, Chairman
Howard W. Sams & Co., Indianapolis

CIRCULATION
EVELYN ROGERS, Manager

ADVERTISING SALES
Kansas City, Missouri 64105
Tele: 913/888-4664
E. P. LANGAN, Director
R. JACK HANCOCK, Manager
JAKE STOCKWELL
JOAN HIRES, Production

REGIONAL ADVERTISING SALES OFFICES

Indianapolis, Indiana 46280
ROY HENRY
2469 E. 98th St.
Tele: 317/846-7026

New York, New York 10019
CHARLES C. HORNER
3 W. 57th St.
Tele: 212/688-6350

Los Angeles, California 90005
JOHN D. GILLIES
3600 Wilshire Blvd., Suite 1510
Tele: 213/383-1552

London W. C. 2, England
JOHN ASHCRAFT & CO.
12 Bear Street
Leicester Square
Tele: 930-0525

Amsterdam C. Holland
JOHN ASHCRAFT & CO.
W.J.M. Sanders, Mgr.
for Benelux & Germany
Herengracht 365
Tele: 020-240908

Tokyo, Japan
INTERNATIONAL MEDIA
REPRESENTATIVES LTD.
1, Shiba-Kotohiracho, Minatoku
Tele: 502-0656



ELECTRONIC SERVICING (with which is combined PF Reporter) is published monthly by Intertec Publishing Corp., 1014 Wyandotte Street, Kansas City, Missouri 64105.

Subscription Prices: 1 year—\$5.00, 2 years—\$8.00, 3 years—\$10.00, in the U. S. A., its possessions and Canada.

All other foreign countries: 1 year—\$6.00, 2 years—\$10.00, 3 years—\$13.00. Single copy 75¢; back copies \$1.

Adjustment necessitated by subscription termination at single copy rate.



Robert E. Hertel, Publisher
Intertec Publishing Corp.
Subsidiary of Howard W. Sams & Co., Inc.

When you need
 a Sprague component "yesterday"
 and our distributor
 doesn't have it in stock...

...ask him to use this form!

Upon arriving at our factory, the order will bypass normal order entry procedures, assuring same-day shipment by air, UPS, or first-class mail, as distance dictates.

Now there's no need to waste time "shopping" for an exact replacement. Any Sprague distributor can get any factory stock item on its way in 24 hours!

THE BROAD-LINE PRODUCER OF ELECTRONIC PARTS



'Sprague' and '®' are registered trademarks of the Sprague Electric Co.

Motorola Attaches Guarantee Label On Color Sets

Motorola reportedly has shortened and simplified its color television guarantee on Quasar II and Quasar portable receivers presently in production.

The company also has started to apply a "basic terms of guarantee" label on the back of these products.

The shortening of the guarantee and the application of basic guarantee labels reportedly resulted from the company's interface with consumers. These moves are also believed to be in line with President Nixon's recent proposal for manufacturers to convey adequate information in simple and readily understood terms in their guarantees.

The guarantee labels are color coded to allow the retail salesman or servicer to quickly refer to the basic terms of the guarantee on each unit. The Quasar portable sets (specified 16- and 18-inch receivers) have a silver label for 90-day carry-in labor, while the Quasar II units (specified 20-, 21-, 23-, and 25-inch receivers) have a gold label for one year in-home labor.

Space is provided on the applied guarantee label for the dealer or consumer to indicate:

- The registered purchase date of the product. This will enable consumers and servicers to tell whether the product is "in" or "out" of warranty.
- The name and telephone number of a qualified Motorola service technician.



- Name and telephone number of the dealer from whom the set was purchased.

The company reportedly continues to pack the complete guarantee terms in the product carton.

The guarantee is effective "only when serviced by a Motorola authorized servicer during normal working hours, and does not cover installation, set-up, travel time or mileage, the antenna system, adjustment of customer controls, foreign use (except Canada), or damage caused by owner misuse."

NATESA Annual Convention

The annual convention of the National Alliance of Television and Electronic Service Associations (NATESA) will be held August 26-29 at the Arlington Hotel, Hot Springs, Arkansas.

Information about convention registration and hotel reservations can be obtained by writing or phoning:

Frank J. Moch
Executive Director
NATESA
5908 S. Troy St.
Chicago, Ill. 60629
Phone (312) 476-6363

An agenda of NATESA convention activities will be published in either the July or August issue of ELECTRONIC SERVICING.

Admiral Combines Service and Training Activities Under One Head

Donald R. Baker, Admiral service manager for the past year, has been assigned the additional responsibility of service training, according to Willis L. Wood, general manager of the national service division of Admiral Corporation.

Admiral service training activities previously had been managed by Ivan F. Johnston, who retired in April.

Townsend Tully now supervises service training functions, under Mr. Baker.

Careful HV Measurements and Adjustments Can Reduce Probability of Color TV X-radiation Concludes HEW

A service-wide program of careful high-voltage measurement and control could reduce the probability of color TV X-radiation exposure, to both viewers and service technicians, according to the Bureau of Radiological Health, an agency of the Health, Education and Welfare Department (HEW).

This conclusion, reported recently in **Home Furnishings Daily**, is based on the findings of an eight-month survey conducted by The Bureau last year in the Baltimore area, with the cooperation of the Electronic Industries Association (EIA) and the Maryland Health Department.

The results of the survey were published by HEW

(Continued on page 6)

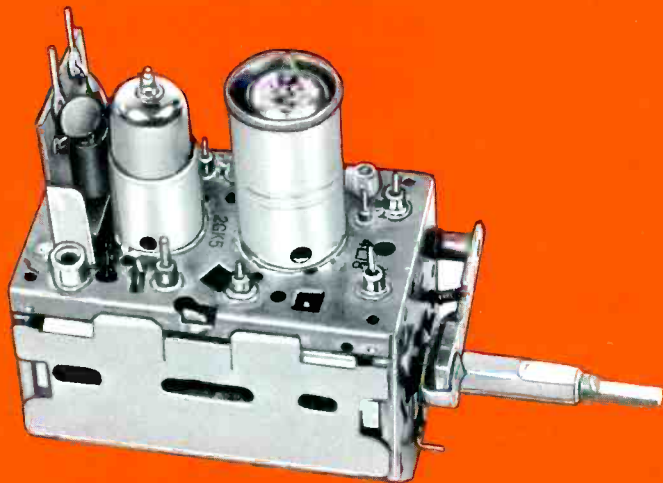

\$975

TUNER SERVICE CORPORATION

PROVIDES YOU WITH A COMPLETE SERVICE FOR ALL YOUR TELEVISION TUNER REQUIREMENTS AT ONE PRICE.

TUNER REPAIR

VHF Or UHF Any Type \$9.75.
UHF/VHF Combo \$15.00.

In this price all parts are included. Tubes, transistors, diodes, and nuvistors are charged at cost.

Fast efficient service at our 4 conveniently located service centers.

1 year guarantee backed up by the largest tuner manufacturer in the U.S.—SARKES TARZIAN INC.

All tuners are cleaned inside and out, repaired, realigned and air tested.

TUNER REPLACEMENT

Replacement Tuner \$9.75.

This price buys you a complete new tuner built specifically by SARKES TARZIAN INC. for this purpose.

The price is the same for every type of universal replacement tuner.

Specify heater type

Parallel 6.3V
Series 450 mA
Series 600 mA

All shafts have the same length of 12".

Characteristics are:

Memory Fine Tuning
UHF Plug In
Universal Mounting
Hi-Gain Lo-Noise

If you prefer we'll customize this tuner for you. The price will be \$18.25. Send in original tuner for comparison purposes to our office in INDIANAPOLIS, INDIANA.



TUNER SERVICE CORPORATION

FACTORY-SUPERVISED TUNER SERVICE

MIDWEST 817 N. PENNSYLVANIA ST., Indianapolis, Indiana TEL: 317-632-3493
(Home Office)
EAST 547-49 TONNELE AVE., Jersey City, New Jersey TEL: 201-792-3730
SOUTH-EAST 938 GORDON ST., S. W., Atlanta, Georgia TEL: 404-758-2232
WEST SARKES TARZIAN, Inc. **TUNER SERVICE DIVISION**
10654 MAGNOLIA BLVD., North Hollywood, California TEL: 213-769-2720

Circle 6 on literature card

NEW AND ONLY FROM EICO-THE INDUSTRY'S LOWEST-PRICED PROFESSIONAL FET-TVM.

- ADVANCED SOLID STATE DESIGN
- BATTERY-POWERED

New Model 239
\$39.95
KIT
\$59.95 Wired



Use the new 239 on your bench or in the field. Checks semiconductor and vacuum tube circuits. 11 Megohm DC input impedance. Reads AC rms and DC voltages in seven 10db steps from 1 to 1000 volts on large 4½" meter. Measures and reads peak-to-peak AC to 2800 volts. Check resistance from 0.2Ω to 1000 MΩ on seven ranges. Includes exclusive time-saving Uniprobe.

2 NEW DE-LUXE FET-TVM's

Includes all purpose DC/AC ohms Uniprobe.

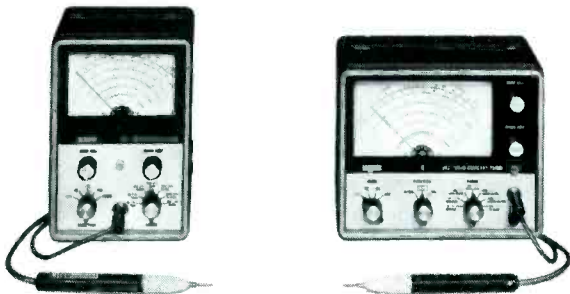

EICO 240 Solid-State FET-TVM. \$59.95 kit, \$79.95 wired. AC or battery operated. 7 ranges each + and - DC volts, peak-to-peak AC volts, ohms. 10 turn zero adjust pot. 4-1/2" 200 μA meter. response to 2 MHz (to 250 MHz with optional r-f probe).

EICO 242 Solid-State FET-TVOM. \$69.95 kit, \$94.50 wired. As 240 plus 7 ranges each AC/DC millimeter, 1 ma to 1A: very low voltage ohmmeter. 10 turn ohms and zero adjust pots. Large 6-1/2", 200 μA meter.

Write for '71 catalog of 200 EICO Top Buys in test equipment, stereo, color organs, science project kits, environmental lighting.



EICO, 283 Malta St., Brooklyn, N.Y. 11207. (212) 949-1100.

Circle 7 on literature card

in a book titled, "A Radiation Survey of Television Repair Shops in the Baltimore Area." The book, No. BRH-DEP71-4, reportedly is available for 50 cents from the Government Printing Office, Washington, D.C.

The survey reportedly was intended as a pilot project for a nationwide survey. However, HEW now has concluded, based on the Baltimore survey, that no further surveys are needed "because the public health significance of radiation exposure to TV is minimal," according to the **Home Furnishings Daily** report.

One- and Two-Year Replacement Picture Tube Warranties Offered Distributors By Sylvania

Sylvania is offering distributors the option of extending the company's one-year warranty on replacement color television picture tubes to two full years.

Luke C. Henrichs, Sylvania general sales manager, said the plan makes it possible for distributors to offer GTE Sylvania picture tubes with the regular one-year warranty or a two-year extended warranty. Both warranties will be backed by Sylvania.

Picture tubes carrying the two-year warranty reportedly are identified by a special yellow label which is affixed to the tube and to the warranty registration card.

Mr. Henrichs explained that participating distributors may purchase the self-adhering labels in booklets of ten. The plan enables distributors to offer an extra year's warranty on color tubes while still maintaining a line of tubes with the normal one-year warranty.

The extended warranty plan applies to GTE Sylvania XR Color Bright 85®, RE Color Bright 85® and Color Screen 85® television picture tubes.

Panasonic Inaugurates Nationwide Service Information Telephone Number

A nationwide toll-free telephone number for servicer location information has been inaugurated by Panasonic's Service Division.

Consumers anywhere in the continental United States reportedly can now dial 800-243-6100 (1-800-942-0655 in Connecticut), tell the operator the product that needs servicing and their zip code number, and they will be provided with the name, address and telephone number of the nearest authorized Panasonic Servicenter.

The toll-free number is in operation 24 hours a day. Consumers reportedly can obtain servicer information regarding all Panasonic consumer electronics products, home appliances and auto products.

Panasonic reportedly has 1,700 authorized servicers in the U.S.

Sale Of One Millionth EIA-Sponsored Servicing Textbook Observed

Sale of the one millionth Electronic Industries Association-sponsored textbook about consumer electronics

(Continued on page 8)

GTE Sylvania has the lines that lay it on the line.

Only GTE Sylvania gives you a choice of three different price lines in color picture tubes.

And GTE Sylvania tells you and your customer exactly what you are getting in each line.

That makes Sylvania tubes easier to sell.

You can tell your customers the advantages of the top-line *color bright 85[®] XR*. You can show them where the savings come from in the economy *color screen 85* line. And you can tell them exactly what they're getting for their money in the middle-line *color bright 85[®] RE*.

The way we see it, if we lay it on the line with you, you can lay it on the line with your customers.

Instead of just handing them a line.



GTE SYLVANIA

	color bright 85[®] XR	color bright 85[®] RE	color screen 85
Sylvania rare earth red phosphors	yes	yes	yes
Other manufactured rare earth phosphors	no	no	yes
All sulfide phosphors	no	no	no
X-ray inhibiting glass	yes	no	no
New glass	yes	some	some
Reused glass	no	some	some
Regunned	no	no	some
Screen blemish specs	OEM	OEM	slightly wider than OEM
White field uniformity	OEM	slightly wider than OEM	slightly wider than "RE"
Cut off: purity currents; beam shield leakage	OEM	OEM	slightly wider than OEM

Circle 8 on literature card

Attention ES Readers:

Troubleshooting-by-Mail Program Changed

The staff of ELECTRONIC SERVICING regretfully announces that increased cost and an overwhelming volume of correspondence force us to discontinue the direct-mail troubleshooting assistance formerly provided ES readers.

Although we no longer are able to reply directly by mail to your request, we still intend to help you solve those "harder-than-usual" troubles with which all technicians occasionally are confronted. When you encounter a troubleshooting situation which has you baffled, please perform the following in the order presented:

- Check the ES Annual Subject-Reference index to determine if the situation was covered in a previous issue of ES. Chances are it has been. (A detailed subject-reference index of the content of the previous year's issues of ES is included in the January issue. If you have lost one or more of these "index" issues, copies can be obtained from the Circulation Department of ES for \$1.00 per issue.
- If you are unable to find adequate information about your problem in a previous issue of ES, briefly describe on a postcard the general type of problem you have encountered, then mail the postcard to:

ELECTRONIC SERVICING, c/o Reader Preference
1014 Wyandotte, Kansas City, Mo. 64105

Although we will not be able to reply to you directly, we will cover the general category of your problem in ES as soon as possible.

ITS YOUR MAGAZINE – LET US KNOW WHICH SUBJECTS YOU WANT TO READ ABOUT AND WE'LL DO OUR BEST TO FULFILL YOUR REQUESTS . . . the editors.

servicing was marked by EIA's Consumer Electronics Group at a ceremony in New York on April 14.

For the past fifteen years the series of instructional manuals on television servicing have been prepared under sponsorship of EIA. The books reportedly are widely used in schools as aids for teaching electronic servicing and are the basis of instruction for television service technicians.

Titles and publishers of books in the series sponsored by EIA include: "TV Symptom Diagnosis, Instructor's Manual," Howard Sams and Co.; "TV Symptom Diagnosis, An Entry Into TV Servicing," Howard Sams and Co.; "Basic TV: Theory and Servicing," McGraw-Hill; "Basic Electronics," McGraw-Hill; "Basic Electricity," McGraw-Hill; "Electricity-Electronics Fundamentals," McGraw Hill; "Basic Radio: Theory and Servicing," McGraw Hill; "Industrial Electronics," McGraw-Hill; and "Advanced Servicing Techniques, (Volumes I and II)," Hayden Book Co.

The Electronic Industries Association (EIA) is a national trade organization of electronic manufacturers. Representing over 85 percent of U.S. electronics manufacturing output, members of the Association range from manufacturers of the smallest electronic part to corporations that design and produce the most complex systems used in defense, space, and industry. The Association's Consumer Electronic's Group represents manufacturers of audio and video consumer electronics equipment.

RCA and Admiral Agree In Principle For Purchase By RCA Of Admiral's Color Picture Tube Manufacturing Equipment

RCA Corporation and Admiral Corporation have agreed in principle that: 1) RCA will purchase Admiral's color picture tube manufacturing equipment, and 2) Admiral will purchase a portion of its color tube requirements from RCA.

Admiral said that its color tube operations have suffered substantial losses.

Sylvania Parts Distributors Named

Sylvania has announced the recent appointments of the following franchised distributors for its electronics component products:

Tyding's
933 Liberty Ave.
Pittsburgh, Pa.

Advance Electronics
804 Dupont St.
Bellingham, Wash.

Rio Radio Supply, Inc.
McAllen, Tex. (branches in Harlingen and Brownsville, Tex.)

Randolph, Hale & Meredith, Inc.
98 State St.
Bowling Green, Ky.

only a BUSS fuseholder could have so many quality features squeezed into such a small package

Space Saver!

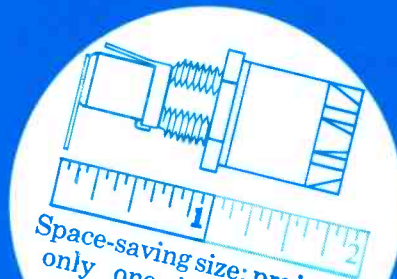

Space-saving size: projects only one inch behind panel, only 1-25/32 inches overall length

Space Saver!

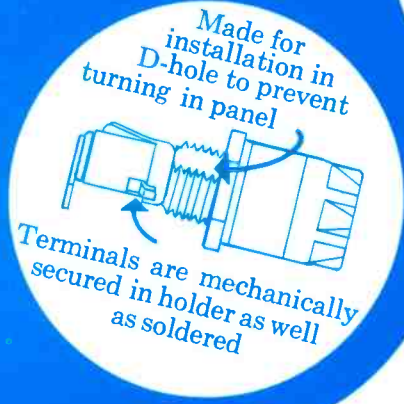

Made for installation in D-hole to prevent turning in panel

Terminals are mechanically secured in holder as well as soldered



Easy-grip bayonet-type knob - sturdy compression spring assures good contact

Knob grips fuse so that fuse is withdrawn when knob is removed

BUSS

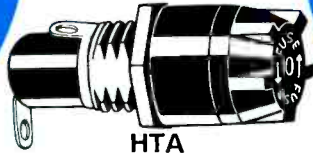

HTA



HTA-DD



HTA-HH

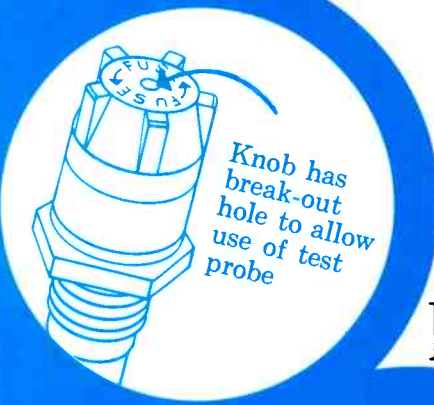

Knob has break-out hole to allow use of test probe



Solder Terminals (HTA)

FUSEHOLDERS

Rated for 15 amps at any voltage up to 250

Dielectrically capable of withstanding 1500 volts A.C. between terminals and between terminals and panel

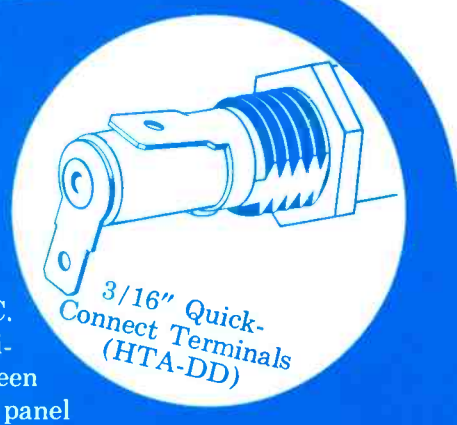

3/16" Quick-Connect Terminals (HTA-DD)



1/4" Quick-Connect Terminals (HTA-HH)

For more information on the HTA Fuseholder and the complete BUSS QUALITY line of small dimension fuses, fuseholders, and fuse-blocks, write for BUSS Bulletin SFB.

BUSSMANN MFG. DIVISION,
McGraw-Edison Co., St. Louis, Mo. 63107



Where do you find a if it's not in Sams

Photofact knows, all too well, the parts unavailability problem a lot of you are experiencing. You can't order a part because nobody knows the OEM parts number, or there's no info available on its replacement.

That bothers us. And annoys *you*.

As you know, Photofact supplies the most comprehensive TV and radio service data in the business. But . . .

A lot of sets sold in America are made abroad. And some manufacturers don't always provide us with parts information and numbers on those sets. Unless their OEM parts are common to regular replacements, nobody knows where to turn for a replacement part.

A couple of other problems: some models may be so new that replacement parts haven't been made for them when Photofact goes to press. Occasionally, a manufacturer delays in giving us full replacement parts information.

Those last two problems aren't as serious as the first one. You'll probably find the information in your distributor's Counter Facts Service if it is a TV or auto radio part. Since we update Counter Facts monthly it often has later parts information than that in Photofact.

We are trying to solve all three problems for you. And you can help.

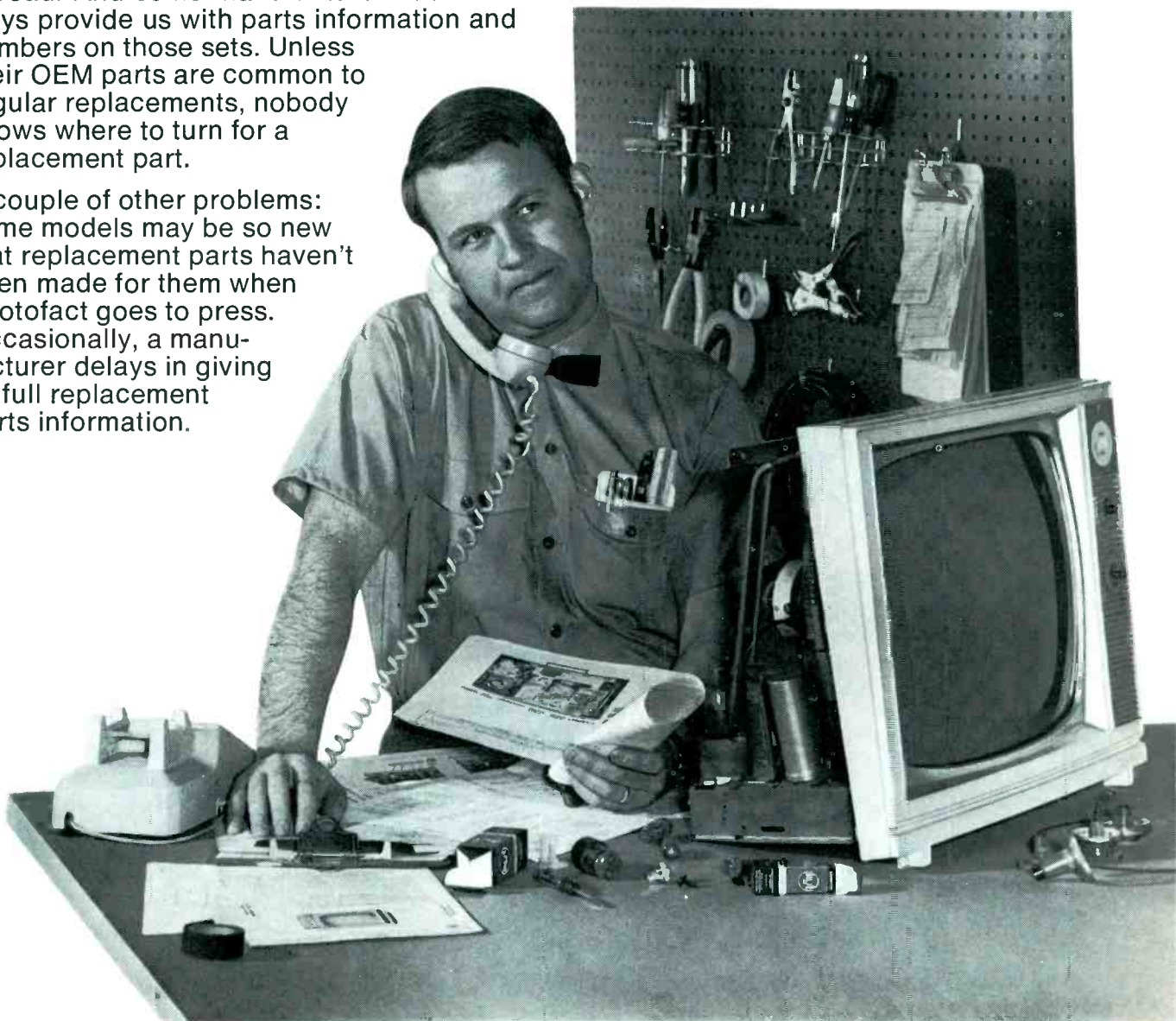

replacement part PHOTOFACT®?

This questionnaire will give us some of the answers. Please fill it out as fully as possible and return it to us. It will help pinpoint trouble areas and speed the date

when every Photofact folder comes more complete. And the information turned up through your help will be shared with the entire industry.

PARTS AVAILABILITY QUESTIONNAIRE

I have experienced difficulty in obtaining certain parts needed to make repairs on the following set(s).

Type of set TV Radio Auto Radio
 Hi Fi Tape Unit

Set Trade Name _____

Model or Chassis # _____

In Warranty? Yes No

Service Data obtained from: Photofact # _____ Manufacturer _____
 Other _____

Part name or function _____

Manufacturers part # _____

Photofact item # _____

Replacement manufacturer _____

Replacement part # _____

Part was ordered from: Replacement Parts Distributor Manufacturer's Distributor
 Set Manufacturer's address as shown in Photofact Annual Index
 Manufacturer's Parts Department Other _____

Date Ordered _____ Acknowledged? Yes No Date _____

Other Comments _____

Your Name _____

Company _____

Address _____

City _____ State _____ Zip _____

Type of Business:

- Service Shop
 General Line Distributor
 Manufacturer's Distributor
 Other _____

Are you a Photofact of the Month subscriber? Yes No

Do you have the 1971 Photofact Annual Index? Yes No
(Which supplement are you using? _____)
Color _____

We appreciate your cooperation in filling out this important questionnaire. Please send it to:

Mr. Joe A. Groves, Manager of Photofact Publications
Howard W. Sams & Co., Inc.
4300 West 62nd Street
Indianapolis, Indiana 46268

ES-061



Howard W. Sams & Co., Inc.
4300 W. 62nd St., Indianapolis, Ind. 46268

Circle 12 on literature card

NEW ... for ES readers only!

CLASSIFIED ADVERTISING

Beginning in the July issue of ES, a classified ad section, titled "The Marketplace", will be made available to electronic technicians and owners or managers of service shops who have for sale surplus supplies and equipment or who are seeking employment or recruiting employees.

Advertising rates

in the Classified Section are:

- 25 cents per word (minimum \$3.00)
- "Blind" ads \$2.00 additional
- All letters capitalized—35 cents per word

Each ad insertion must be accompanied by a check for the full cost of the ad.

Deadline for acceptance is 30 days prior to the date of the issue in which the ad is to be published. (July inserts must be received by June 1).

Send
insertions
with full
payment to:

Electronic Servicing
Classified Advertising
1014 Wyandotte Street
Kansas City, Mo. 64105

(The Classified Section is not open to the regular paid product advertising of manufacturers. Classified advertising is intended as a service to technicians and shop owners or managers seeking employment or recruiting employees or who wish to dispose of surplus supplies and equipment.)

■ Electronic technicians and owners or managers of electronic service shops who need assistance obtaining a part, service literature or any other item related to the servicing of electronic equipment are invited to use this column to inform other readers of their need. Requests submitted for publication in this column should be sent to: Readers' Exchange, ELECTRONIC SERVICING, 1014 Wyandotte St., Kansas City, Mo. 64105. Include a brief but complete description of the item(s) you need, your complete mailing address and how much you are willing to pay for the item(s). Individuals responding to a request in this column should write **direct** to the requestee.

Help Needed

We have a Sears Roebuck, Model No. 863-62200 Automobile Monaural Tape Player for which we are unable to obtain cartridges.

These cartridges were of an unusual design, so-called "horizontal tape path feed".

Sears Roebuck discontinued this model several years back. Cartridges are no longer available.

Would anyone happen to have any of these cartridges laying around in their shops? We will gladly reimburse the expenditures.

Rev. Henry Preneta
Electronic Club Instr.
Box 295
Adah, Pa. 19410

I need the schematic and operating manual for a Golden Shield, Model 9170 Transistor Radio. These are the only words on the radio that indicate a brand name. I am sure it is a Japanese import but only have the words Golden Shield to go on.

Any help on locating information on this particular radio will be greatly appreciated.

Scott A. Magness
130 Flagler
Miami Springs, Fla. 33166

I need the schematic for a Sun Mark solid state 2-speaker, AM/FM/AFC clock radio. The model number is SM14CAC and it uses 10 transistors.

Tom's Radio & TV Repair
2515 E. Tilton St.
Philadelphia, Pa. 19125

I have a FENCO Model FCR-107 cassette tape recorder for repair and can not locate a source for parts and data.

It will be appreciated if someone could supply the name and address of the importer or other source of

(Continued on page 14)



WITH AN RCA ICTJ SYSTEM, YOU CAN SERVICE ALMOST ANY COLOR SET FROM A TO Z (ADMIRAL TO ZENITH)

And just about everything in between. Andrea. Catalina. Curtis Mathes. Sharp. (Plus RCA, of course!)

Over 5000 models from 36 manufacturers.

RCA's complete Industry Compatible Test Jig system allows you to service more than 90% of the color TV consoles now on the market. Fast and easy.

The RCA ICTJ system includes the test jig itself (in bench or portable models), your choice of 102 adaptor cables and a cross-

reference manual that matches the right adaptors to the right set. Order the adaptors you need, and keep ordering others as you need them. After your Distributor registers your purchase of the test jig, you will receive your copy of the manual, and periodic mailings of new inserts to keep the manual up to date.

If color TV servicing is your business, RCA's ICTJ belongs on your bench.

Talk to your RCA Parts and Accessories Distributor today for full information.

TRUE TRIGGERED SWEEP OSCILLOSCOPE/VECTORSCOPE

MODEL TO-50

- DC to 10 mhz frequency response
- .02 volt sensitivity
- Calibrated vertical attenuator
- Calibrated time base
- Supplied with combination direct/locap probe
- 5 X magnifier
- Automatic triggering mode
- 5" flat face tube edge-lit graticule

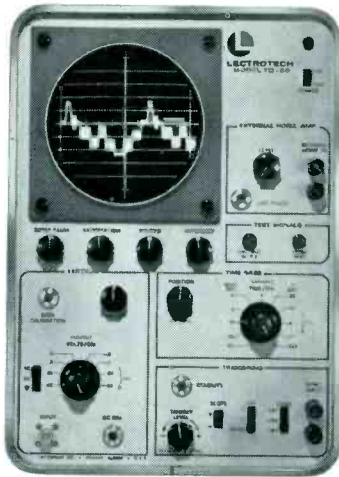

One Year Warranty \$ **339⁵⁰**
All American Made **NET**



See your distributor or write Dept. E-4
LECTROTECH, INC.
4529 N. Kedzie Ave., Chicago, Illinois 60625

Circle 15 on literature card

DEALER INVENTORY PACKAGE OF COLOR TV CONTROLS

ALMOST ALL REQUIREMENTS OF
2-4 WATT WIREWOUND CONTROLS



ASK YOUR DISTRIBUTOR FOR
THIS TIME SAVING PACKAGE

MANUFACTURED BY
WORKMAN *Electronic*
PRODUCTS, INC.
P.O. BOX 3828 SARASOTA, FLORIDA 33578

for
**RCA
SEARS
ZENITH
ADMIRAL
MOTOROLA**

including
CONVERGENCE
AUDIO - COLOR
A. G. C. DELAY
BRIGHTNESS
SENSITIVITY
HORIZ. FREQ.
HORIZ. CENT.
VERT. LINE.
VERT. CENT.

FREE!
CROSS
REFERENCE

Circle 16 on literature card

parts and data for FENCO products.

McLester Brown
130 SW 48th Court
Miami, Fla. 33134

I need an operators manual for a Dumont oscilloscope, Model 303-A. Any information shall be greatly appreciated.

LaGrange Park, Ill. 60525
Alan C. Jacques
201 Timber Lane

I would like to buy two used test instruments in good condition—well known brand, if possible.

- 1) Sweep marker generator for VHF and UHF channels including chroma bandpass.
- 2) A five-inch scope (wideband) to troubleshoot color TV.

All necessary probes included, plus service manuals to equipment. Total cost not to exceed \$75.00 in all. All letters will be answered promptly.

Louis Jankowski
2731 Valley Ave. NW
Grand Rapids, Mich. 49504

I need the variable resistor R₅, 250-ohm, 2-watt (or R₅ and R₆ if not available separately) for a Paco C-25 in-circuit capacitor tester.

A 13CM5 tube or other tubes for Philips or Rogers Majestic, may be obtained from:

Double Diamond Electronics
115 Vanderhoof Ave.
Toronto 17, Ontario, Canada

or

540 Marjorie St.
Winnipeg 21, Manitoba, Canada

Gordon Martin
484 7th St.
Nanaimo, B.C.

We need a schematic and source of supply of replacement parts for a USL-Contact Z3, CB 7000 series, Serial No. B38368 Citizens-Band Transceiver, made by United Scientific Laboratories, Inc., a Division of Vernitron Corp.

Any help will be greatly appreciated.

John Hogelin
112½ North 13
Box 915
Parsons, Kans. 67357

I would like to obtain a replacement power transformer for a Model E-400, Serial 4012 Precision Apparatus sweep signal generator.

Frank Zablocki
531 Ferry Road North Haven
Sag Harbor, N.Y. 11963

(Continued on page 16)

PTS

(PRECISION TUNER SERVICE)

Has finally succeeded in dividing the country

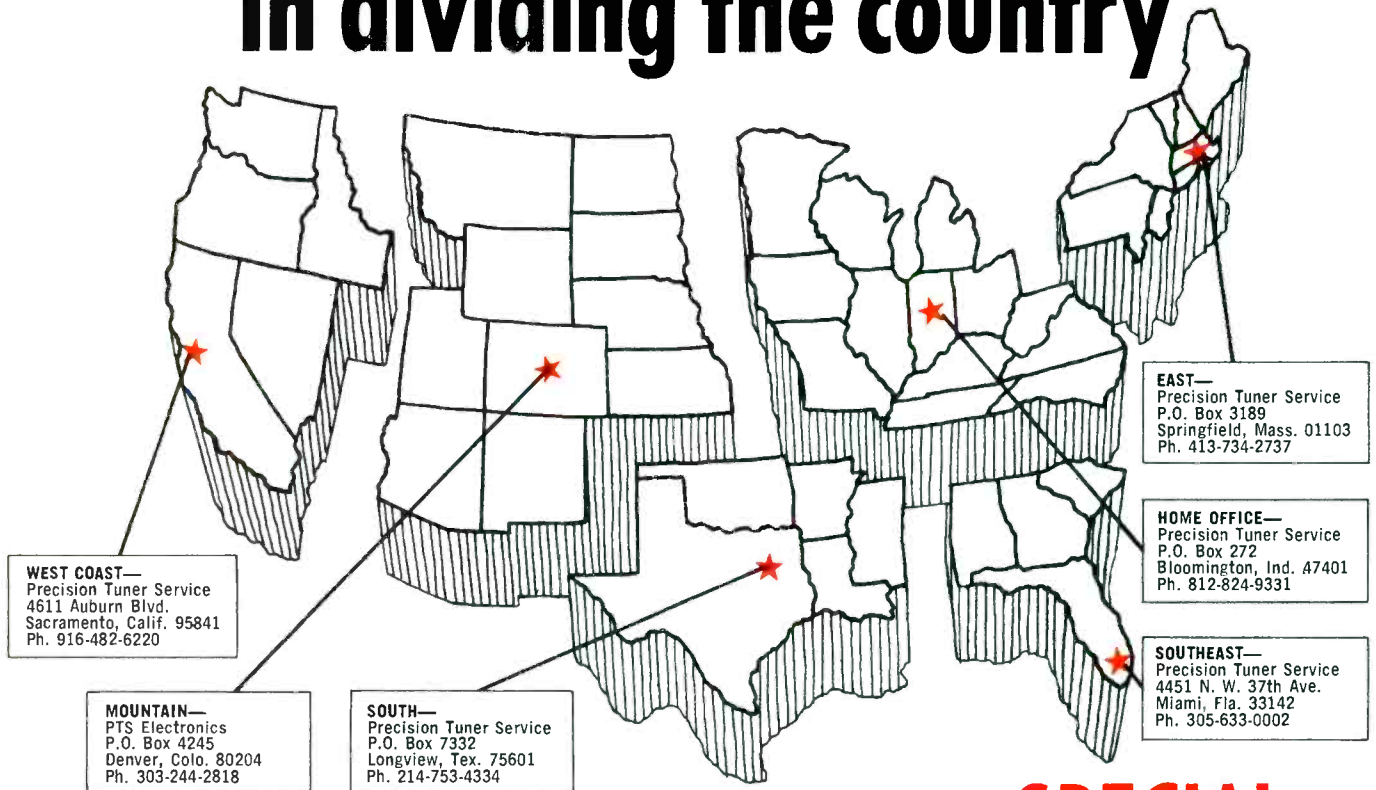

YOU OWE IT TO YOURSELF

... to try Precision Tuner Service.

We are the fastest growing, oldest and now the largest tuner service company in the nation.

Here is what you get:

1. Fastest Service—8 hours—in and out the same day. Overnight transit time to one of our six plants.
2. Fine Quality! Your customers are satisfied and you are not bothered with returning tuners for rework!
3. Lower Cost! Up to \$5.50 less than other tuner service companies.
4. Friendly, helpful service! We help you do more business—that way, we will do more, too. We want your business and we try to deserve it!

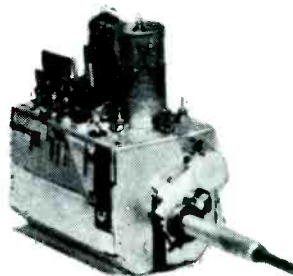

SPECIAL ANNOUNCEMENT

NEW, NEW, NEW! To be of better service to you, we now make all tuner parts and antenna coils available to you. PTS also has the largest stock of original replacement tuners.

A catalog of our complete line of tuner replacement parts is available to you upon request.

For more information on this or our fine tuner service call or write to:



PRECISION TUNER SERVICE | P.O. BOX 272 • BLOOMINGTON, IND. 47401
TEL. 812, 824-9331

Circle 17 on literature card

RMS 'STAR-TRACK'

"SPACE-AGE" VHF/UHF/FM

COLOR ANTENNAS

FOR ALL AREAS!

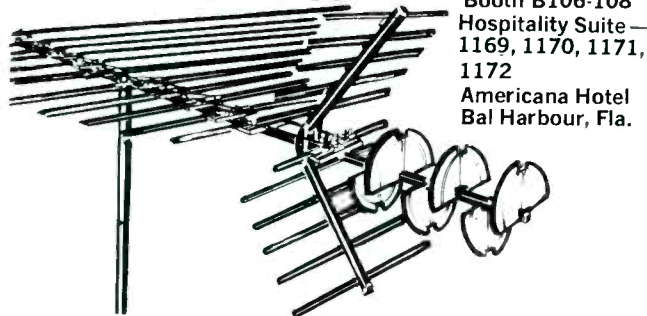

See
Booth B106-108
Hospitality Suite—
1169, 1170, 1171,
1172
Americana Hotel
Bal Harbour, Fla.

Similar design to Space Tracking Antennas! Combines the "Corner Reflector Disc Director Array" for total UHF coverage, with "Multiple Tuned, Cut-to-Channel, VHF Elements" for unsurpassed Color and Black and White TV! Includes VHF/UHF Splitter for economical single down-lead installation. Licensed under U.S. Pat. No. 3,440,658 of Richard D. Bogner the designer of many Antennas used in the Space Program!

6 "Performance Proven" Antenna models for all areas—write for FREE illustrated Specification Brochure.

RMS ELECTRONICS, INC.

50 Antin Place, Bronx, N.Y. 10462 • (212) 892-6700

Circle 18 on literature card

Coming next month ...

- Interpreting TV Vertical Waveforms
- Troubleshooting Solid-State Audio Amplifiers
- Servicing Stereo FM Auto Radios
- All About Triggered-Sweep Scopes
- "Signal" vs "No-Signal" Voltages In TV
- How To Test Zener Diodes
- Bookkeeping and Accounting (continued)

If its about servicing consumer electronic products, you'll read about it in

Electronic Servicing

—the professional electronic technician's magazine.

I need schematics for the following two radios:

- 1) Freed Eisemans,, Model NR5 or No. H771, a regenerative set probably made in the late 20's or 30's.
- 2) Federal Telephone and Telegraph Radio, Type 57, made in Buffalo, N.Y. A 4-tube set using 301-A's. an early 20's model.

Willis E. Dewey
1225 S. Sullivan
Santa Ana, Calif. 92704

I need the schematic and operating instructions for a Model TV-50A Genometer. I would also like to know the manufacturer of this equipment.

Joseph Elie
624 Lafayette Ave.
Brooklyn, N.Y. 11216

I need the book of instructions and tube checking information for a Model TV-10 tube tester manufactured by Superior Instruments Co. Any information will be appreciated.

B. Roberts
P.O. Box 384
Oxnard, Calif. 93030

I am looking for old-time battery and crystal radios, horns, radio catalogs, magazines, service literature and parts. I am opening a radio museum and need articles from the 1920's era.

Robert A. Lane
2603 Independence Ave.
Kansas City, Mo. 64124

I need test equipment for all types of two-way radios. I also need manuals, parts and used equipment.

Larry Dumas
1715 47th
Lubbock, Tex. 79412

I need the manual and schematics for a Hycon, Model 622 scope. Would be glad to pay for a copy of one, please send C.O.D.

H. W. Atteberry
Rt. 3 Box 773
Ft. Collins, Colo. 80521

I am trying to locate a schematic diagram for an old vintage radio which I would like to restore. It is a 1929 Victor Amplifier, type 245, Serial No. 12823, made by the Victor Talking Machine division, Radio Victor Corp. of America, Camden, N.J.

Any help would be appreciated and any cost involved will be met promptly.

J. Apsitis
19 Tamarack Ave.
St. Catharines
Ontario, Canada



When people
turn to you
to make things
right again ...

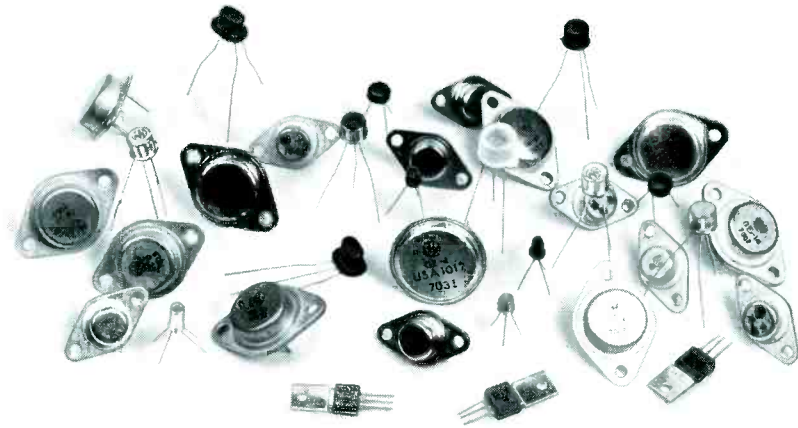

use GE semiconductor replacements
(made by professionals for professionals)

TUBE PRODUCTS DEPARTMENT • GENERAL ELECTRIC COMPANY
OWENSBORO, KENTUCKY 42301

GENERAL  ELECTRIC

Permanent and Clear Labeling of Chassis

Following is a letter sent to consumer electronic product manufacturers by Frank J. Moch, Executive Director, National Alliance of Television and Electric Service Associations:

Service technicians are becoming ever more concerned over the great and unjustifiable waste of time caused by difficulties in identifying sets before they can proceed with service. Quite often, too, set owners with clear troubles, such as defective on/off switches or obviously dead picture tubes, must pay for an extra service call simply because model number identification is missing or blurred and is not available to the servicer when he calls. If it were available, it would permit bringing the needed part on the first call.

Use of rubber stamp marking, especially with inks that do not permanently adhere, or which is of a color almost the same as the background, is quite senseless. Surely there are available many pressure sensitive labels of an infinite variety of colors and imprint absorption, that defy removal, which could be imprinted even with rubber stamps. Such labels of a contrasting color and bearing only the make and model number, and perhaps the serial number, would permit more rapid service with more time devoted to actual problem correction, which would result in lower cost to the set owner. A similar label on which is included chassis identification should be affixed to the chassis.

Such permanent labels, too, would help identify stolen sets and thus deter burglars.

Inasmuch as this idea will add little if any added cost, we sincerely hope this idea will be promptly adopted by all set producers.

Frank J. Moch
Executive Director
NATESA

The Servicer and The Law

The editors of ELECTRONIC SERVICING are correct; our problems are so ingrown and many that it is hard to conceive.

First we need justice. For example, I never issue a warranty, but four times out of four when I try to collect in court, the judge requires me to issue one. Recently, a judge who... admits that the law does not require me to issue a warranty, "invented" a warranty for me.

The first time (in court) surprised me. I was forced to pay for a picture tube to make good on a warranty

on a set sold by another man 2½ years before.

In most cases you spend \$50.00 trying to collect \$50.00...

We need a method to collect. Credit information should be available to us. A mans right to cheat is so protected that some take a community for 5 to 20 thousand dollars before moving on.

Manufacturers warranties rob the serviceman. For example, the single lot price of a 2N3731 transistor is \$1.62. An ECG127, which replaces it, costs the servicing dealer \$7.50. Turn in the old part (to the manufacturer) and you get \$1.62, not the \$7.50 which you deserve.

Charles Williams
Williams of Henry TV and Radio
Henry, Ill.

Reaction To Duncan Hines Commercial

I do not understand the hue and cry over the Duncan Hines TV commercial. I thought it was hilarious, and very true and to the point. Proctor and Gamble gets my most profound kudos, and it should shake up the radio, TV and electronic technicians to no end!

There is no reason for the NEA to become upset about the commercial, and if it crushed some toes, it should also have crushed some noses or mouths of the dissenters, especially the various associations that are worthless, for the most part.

For the last 38 years I have tried to lift the level of the electronic service profession in the eyes of the public, and ten years of my efforts were in the capacity of an official in one of the oldest radio and TV associations in the world. I spent many hours futilely trying to get the "boys" to standardize prices and try and get the incompetents out of the trade.

I remember when a member of the association's relative died. There was not even a card sent; however, when a technician, who was not even in the association, had the same bereavement, (and was to become a member), his family received flowers, money, cards, and all the niceties, in order to acquire a new member.

This price cutting and sloppy work is universal. I remember one association member, who, when out on a service call, had to buy a part or tube from another association member, for the list price. This is fraternity? Another member I know was charged five times the list price for a tube socket, simply because he was in his "association members" territory.

There was a criminal case made on a technician, who was an association member. He picked up a TV for service while no one was home. Although he had written permission to enter the house while no one was home, he was indicted for breaking and entering, with intent to commit a felony. This court case ruined his business and disgraced his family. Not one association member came to his rescue or even attempted to offer assistance! I know of no laundry man, milk man, oil man or any other tradesman who ever was arrested for this same situation, and if they were, you could bet your bottom dollar that their

(Continued on page 20)

GE is bringing in panels of independent experts to tell us how to make our new products more serviceable.



They tell us. And we listen. And we'll have better products for it. This is just one of the things that GE has been doing to improve the serviceability and parts availability of our television products.

For the last several months we have been paying the transportation on warranty parts. We've also installed direct telephone lines to regional parts centers. And, soon, we'll have three hundred independent parts distributors throughout the country.

We're out to make GE television products as easy and inexpensive to service as possible. We have a little way to go yet. But we're doing something about it.

For additional information about GE service, call collect or write "Dutch" Meyer.

GENERAL  **ELECTRIC**

Television Business Division • Portsmouth, Virginia • (703) 484-3521

Send a Complimentary Copy of Electronic Servicing to your Friends in the Business

Know some electronic technicians who might benefit by reading *Electronic Servicing* as you have?

Just fill in their names and addresses below—and your name and address—and tear out and mail to *Electronic Servicing*.

We'll send each one of them a copy of *Electronic Servicing*, with your compliments.

You'll do us and your friends a favor by helping spread the good word about the only magazine devoted exclusively to consumer electronic servicing.

Name

Address

City..... State..... Zip.....

Name

Address

City..... State..... Zip.....

Name

Address

City..... State..... Zip.....

Name

Address

City..... State..... Zip.....

Name

Address

City..... State..... Zip.....

Your Name and Address, Please

Name

Address

City..... State..... Zip.....

Tear Out Your List of Names And Mail To

Electronic Servicing

1014 WYANDOTTE STREET, KANSAS CITY, MISSOURI, 64105

company, union or association would come to their rescue. In the case of the technician, he was forced to pay for his own lawyer and the court costs. Of course he was vindicated, but think of the misery he went through.

I know of nothing, I mean nothing, constructive that any association in this land has ever accomplished that the law or manufacturers did not finally get around to doing. I have never, in 38 years in the business, been neglected by any manufacturer with regards to schematics, parts, etc. They have been most cooperative and helpful. However, any technician who pencils the address on a 5-cent postal card and writes unintelligible notes that have to be decoded, or deciphered, deserves to be ignored. Some of the requests sent to the manufacturers are absolutely horrid and defy description. However, when the technician does not get his information, he, of course, (especially if he is an association member) is bewildered, and blames the manufacturing concern.

If most all the electronic technicians in the land would take stock of themselves they could certainly trace all the mendacious . . . procrastinating troubles right back to where it all started . . . themselves. And until they do this, and take stock of themselves, no association in the world can help.

The associations, national and local have one thing in common. They publicize their troubles by washing their dirty linen in public, and hold meetings for the sole purpose of finding out "what the other guy is doing", so that they can get the "other guy's business", by discount pricing. My findings are based on fact and 38 years of dealings with the associations, which are by far harder, much harder, to do business with than the average customer.

Hooray for Proctor and Gamble and pass the Duncan Hines cake please! It seems to me that the officials of the NEA are sadly lacking a sense of humor. If they want to recover the sense of humor we were born with, I suggest they get out of association work, or they will end up on the couch!

Joseph T. Beck
Tampa, Fla. 33616

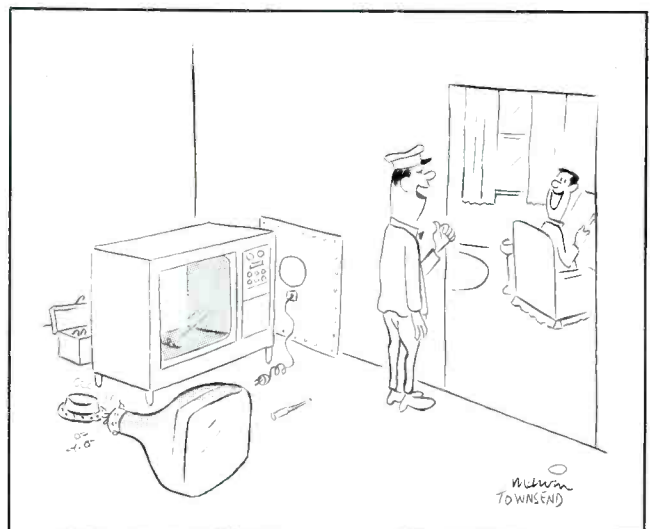

"You'll be relieved to know it's only one tube causing all of your trouble."

bookreview

Transistor Substitution Handbook, Volume No. 11 (Catalog No. 20835)

Author: Howard W. Sams Engineering Staff

Publisher: Howard W. Sams & Co., Inc.

Size 5 3/8 inches x 8 7/16 inches, 160 pages

Price: Softcover, \$2.25.

A list of computer-selected and manufacturer-recommended substitutes for both domestic and foreign-made transistors. Section 1 is a numerical and alphabetical listing of transistors, to the right of which are listed the other available transistors which have identical or similar electrical characteristics. The physical dimensions of the selected substitutes are approximately equal to or smaller than the original, so that the replacement will fit into the space occupied by the original. Replacement power transistors selected by the computer have similar cases, styles and physical dimensions. Substitutes recommended by the manufacturer or supplier of a general replacement series are listed after those selected by the computer and are indicated by an asterisk. Transistors which are no longer manufactured are preceded by a dash. Section 2 provides two listings of general-purpose replacement types of transistors, by both type and application. Included in these listings are the polarity (NPN or PNP), and type of material (germanium or silicon) of the transistor and the manufacturer.

Contents: Guide to Making Transistor Substitutes—Transistor Substitutes—General-Purpose Replacements.

ELECTRONIC SERVICING. . .
the country's only magazine
devoted 100% to the
ELECTRONIC SERVICING
industry . . .

The RCA portable color bar generator



Performs like the big ones Costs only \$75*

- Provides color bar, dot, cross hatch, and blank raster patterns
- All solid state circuitry including ICs
- Pattern signals, RF output frequency and color subcarrier all crystal-controlled
- Battery operated, AC adapter available
- Lightweight — less than 20 oz., only 6 1/2" wide x 4" deep x 3" high

For all the technical specs get in touch with your RCA Distributor. RCA | Electronic Components | Harrison, N.J. 07029.

* Optional User Price

Circle 21 on literature card

Double-Entry Bookkeeping Simplified

by Robert G. Amick/ES Business Editor

Fig. 1 Illustration of T-Account

		Springville Hospital					
		Ledger Account					
	Date	Item	Debit		Date	Item	Credit
1	6/20	Service of 3 sets	8110	1	7/6	On account	8110
2				2			
3				3			
4				4			
5				5			

Mike Farad sat across from Jim Keeper in a booth at the Rainbow Cafe.

"Okay, Keeper, you promised to explain Debits and Credits to me. I'm ready. Start explaining," Mike ordered as they finished their meal and waited for more coffee.

"Right, Mike. First, though, I want to tell you that we're really impressed by the care with which you prepare your daily reports and the promptness with which you provide us information. You're getting to be our favorite client. You really care how your books 'work up' and really want to know all they can tell you. I noticed this when we went over your first monthly report together this afternoon. You asked some pretty perceptive questions," Jim commented.

"Increasing your understanding about the bookkeeping process and related theory will give you a better understanding of what we're trying to do for you in the monthly reports and summaries."

What Debit and Credit Really Mean

"To begin with, I ought to explain that the bookkeeping meanings of Debit and Credit aren't always the same as their meanings in the common language. In everyday conversation, when you say something's to a man's credit, you mean it's on the plus side. That's **not always** true in bookkeeping."

"Okay. The first thing I should do is forget my own notions of what Credit and Debit mean," Mike declared. As he spoke, he made notes in a pocket notebook. (This is a habit he developed when he began reading library material on business management, or talking to experts about it.)

"One thing you **can** go on believing—a Credit is the opposite of a Debit, and vice versa, in a given situation.

"I'm going to have to be just a little theoretical in some parts of this explanation. I'm sorry if that part doesn't grab you, but a little theory really doesn't hurt. I'll try to keep it at a minimum. You remember, don't you, that every transaction affects the different values, or some of them, in the Bookkeeping Equation?"

"Sure. I learned that when I learned that Assets equal Liabilities plus Proprietorship," Mike recited.

"Well, then, you also know that recording the effects of transactions is what bookkeeping is all about. That's where Debits and Credits make their grand entry. Every transaction has a Debit part and a Credit part. A professional bookkeeper is an expert at analyzing these two parts of the transaction, to see that they're correctly entered. It really isn't so complicated, once you break the habit of thinking of Credits as pluses and Debits as minuses. It's just about the same as your ability to analyze what 'goes into' an electronic circuit and what 'comes outta,' wouldn't you say?"

"Double Entry" Explained

After a pause, Jim continued: "This might be just the best place to explain that we're talking about **Double Entry** bookkeeping. It's called Double Entry because it's always concerned with the two parts of a transaction we've been discussing—the Debit part and the Credit part. It records both elements in each case—so there's always a double entry, one for the Credit and one for the Debit. There may be more than two—since either the Credit or the Debit may be broken

Fig. 2 Showing how T-Account entries derive from the Balance Sheet.

BALANCE SHEET

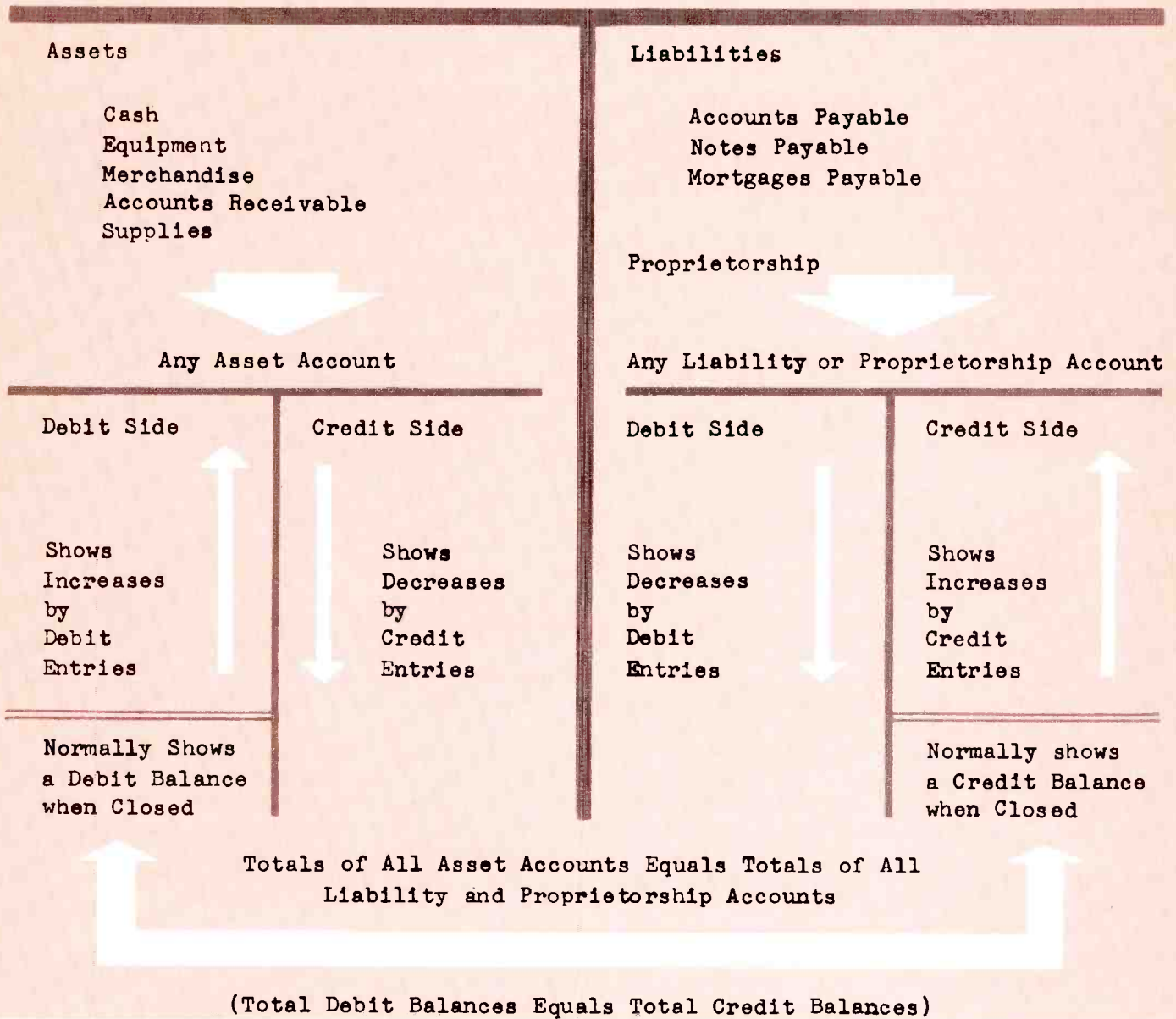

down into several components. But there must be at least two, equal entries—the Debit and the Credit entry. In other words, the sum of the Credit entries must equal the sum of the Debit entries. This is true for any transaction.”

Mike offered a comment and a question: “I’ve always heard people say Double Entry was too complicated and too hard to learn. How about it?”

Jim agreed, mildly. “Double Entry is a bit more complicated, since there is a little more to it than just writing a note in a book. It is a bit harder to learn, too, because you have to learn to analyze your transactions, to determine what is the correct Debit and Credit entries.

“But it really isn’t that complicated, or that hard. It’s the only really systematic method. It keeps track of what’s happening to all three elements of your Balance Sheet, so you get a complete, accurate knowledge of the condition of your business. More than

that, Double Entry is the only system which allows you to prove the accuracy of your books by balancing them at the end of your fiscal period—month, quarter or year.”

“Balancing The Books” Explained

“What does ‘balancing the books’ really mean, Jim?” Mike inquired. “I always figured it meant seeing to it that your income was greater than your expenses, but I suspect that there’s more to it than that.”

“Actually, Mike, there’s a lot more to it than that. Since every transaction has a Debit part and a Credit part, it follows that there will be Debit balances and Credit balances at the end of your fiscal period. Totaling all the Debit balances and all the Credit balances should give you two equal totals. If they’re equal, your books balance. Your recording and posting accuracy are established and that’s that. If they aren’t equal, your books don’t balance and there has to be an error

someplace. You have to search for it and correct your books so that they do balance. This 'proof system' is built-in—just by maintaining the Debit and Credit parts of each transaction in the records.”

Jim paused a moment for emphasis, then continued: “Actually, the whole business of Debits and Credits begins with the Balance Sheet, Mike. You’ll recall that Assets are on the left of the Balance Sheet and that Liabilities and Proprietorship are on the right? Practically everything in Bookkeeping follows that left-side/right-side division.”

As he talked, Jim sketched out an illustration like that in Fig. 1. He pushed it across to Mike.

The “T-Account”

“This is called a T-Account form, Mike. It’s the way bookkeeping ledgers are generally divided. The left side is the Debit side, and the right side is the Credit side. As you can see, the main dividing lines give it the shape of a T. It’s just a little device to help us remember the Debit/Credit procedures, and to teach them. Accountants and bookkeepers, by common acceptance—what’s called a convention—have decided that the left-right division is a good basis on which to set up this system.

“So, accounts on the left-hand side of the Balance Sheet show their increases on the left side of the T-Account. That means any Asset account is increased by a Debit entry and decreased by a Credit entry. Normally, the closing balance of an Asset account will be in the Debit column, too. In the same way, the right-hand side accounts on the Balance Sheet—Liabilities and Proprietorship—show their increases on the right, or Credit, column. Their balances usually will be there, too.”

Again, Jim’s pencil had been busy as he talked. The illustration he produced resembled Fig. 2.

Mike studied the sketches, then suddenly demanded, “You mean there isn’t any exact definition of Debit or Credit I can write down?”

“Sorry, Mike. No real, permanent definition at all. I’m sorry if that disturbs the serious student in you, but there it is. No definition. I can give you a little help—they’re abbreviated “Dr.” for Debit and “Cr.” for Credit, Jim laughed.

“To get off onto the history side for a moment, some unknown Venetian trader is credited with inventing Double Entry bookkeeping. He just picked those names, or had them handed to him by whatever preceding bookkeeping system he began with. He had to be a pretty radical thinker to use a couple of words that couldn’t be defined five centuries ago.

“Really, you can say that Debit and Credit are defined by their use and that their definitions change every time they cross the left-right dividing line of the Balance Sheet-T-Account system. As I said, the

one fixed definition they **do** have is that, in any given type of transaction, one is the opposite of the other. If Credit means increase, then Debit means decrease. If Credit means decrease, then Debit has to mean increase.”

“And it all depends on which side of the Balance Sheet we’re working on?” Mike said.

Jim agreed. Then he offered a few examples to test Mike’s understanding.

Debit or Credit? . . . Increase or Decrease?

“You get a check from the hospital for servicing their TV’s. How do you enter it on the books?”

Mike thought a moment, checked the T-Account sketches, and then answered: “That’s Cash, which is an Asset. Assets show increases on the Debit side. So I enter the amount of the hospital’s check as a Cash Debit.”

“Correct! Now, what about the other half of the transaction?”

Mike clapped his forehead with his palm. “You’ve caught me, there, Jim. I forgot we were dealing with two parts. Okay—I’ve Debited Cash so I have to have a Credit entry now.”

He thought a moment, then reported, “Their payment reduces my Account Receivable for them, so I credit their account with the payment.”

The bookkeeper nodded enthusiastically, “You’re catching on, Mike.”

“Now, you pay a parts supplier at the end of the month. Analyze that one for me.”

“I pay him by check. That’s Cash, so the amount of my check is a Cash Credit entry. I’ve reduced my liability to him, so that’s a Debit to Accounts Payable.”

Jim smiled approvingly. “Right. And, by the way, that one illustrates why Debits can’t be defined as decreases (or Credits as increases), as so many laymen seem to think they are. It created a reduction on either side of the line. Just for review, what does that reduction do to your Proprietorship?”

“Absolutely nothing. Subtracting equal amounts from both sides of the equation leaves the other elements unchanged.”

Mike was quiet for a moment, then said thoughtfully:

“Jim, I’m beginning to see it clearly. Transaction-by-Transaction you do have that same thing going on most of the time—additions or subtractions of equal amounts on both sides of the equation. So, naturally, the equation stays in balance so long as the parts are accurately recorded.

“You know, that Venetian trader had to be a pretty sharp cookie to develop a system in which your books have to stay in balance unless there is an error.”

“Even smarter than that, Mike. He figured out the Bookkeeping Equation, too. Remember, that’s what

Fig. 3 Special Case of Income and Expense Accounts by T-Account form.

(Balance Sheet)

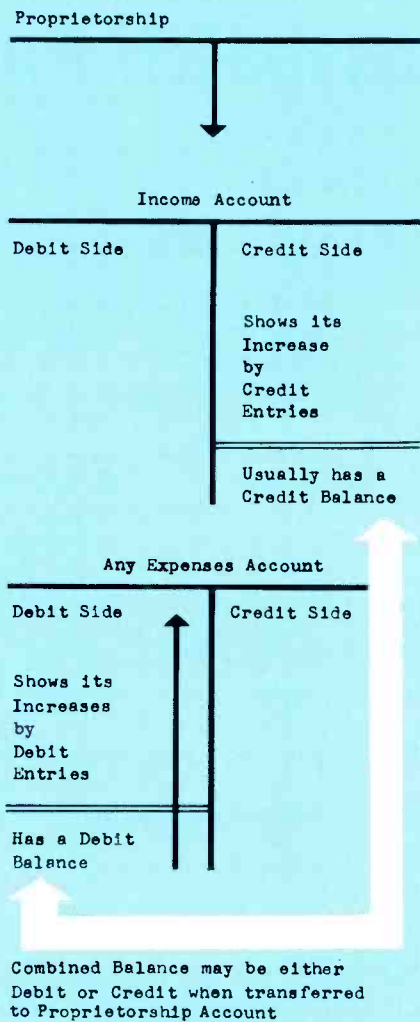

three Debits would equal the Credit part. Right?"

"All the way. Now, what happens to the Bookkeeping Equation as a result of that transaction?"

"Nothing. I've converted one asset—Cash—into another—Equipment. Whoops! No I haven't got that right. I've also paid taxes and freight. They're expenses and they reduce my Proprietorship, and my Cash Assets, too."

Jim brightened noticeably when Mike caught his own error.

"Mike, I think you've got Debits and Credits pretty well under control. When you're looking at your records, and you have time, you might like to keep thinking out the Debit-Credit parts just to solidify your understanding. What do you say we call it a day?"

Mike offered the opinion that Debits and Credits weren't really as difficult as he'd expected and that he really didn't see what all the fuss was about. But then he motioned Jim back to his seat.

Entries on Income and Expense Accounts Are Different

"One thing you haven't covered, Professor. What about Income and Expense Accounts? Do they follow the same rule of showing increases as Credits, since they're on the right-hand side? I just remembered that, in your last question, I had an expense increase as a Debit."

"So you did. They're kind of a special case, because they aren't really part of the Balance Sheet. That ends with Proprietorship, you recall."

"What do you mean 'special case'? Seems to me you're weasel-wording. What's the story?" Mike demanded.

"They're not Balance Sheet items, but they directly affect one of the Balance Sheet Items—Proprietorship, which can be increased only by Income and can be decreased only by Expenses. So, the Income and Expense Summary is included under Proprietorship so that its balance can become part of the Proprietorship account when the books are closed."

As he spoke, Jim sketched out Fig. 3. He handed it to Mike and traced the arrows with his pencil as he explained.

"I suppose you could say that Income and Expenses are subordinate accounts in the Proprietorship section of the Balance Sheet. That's where they have their main effect. In the individual accounts, Income is shown as a Credit; Expenses as a Debit. When they're summarized for transfer to the Proprietorship account, it will fit the rule of the T-account. If Expenses exceed Income, there will be a Debit balance to transfer. That's a decrease—on the right-hand side, so it is a Debit. If Income exceeds Expenses, the Summary has a Credit balance—an increase—to transfer. As I said, the rule will be satisfied." ▲

it all hangs on. He had to have a real grasp of business to figure out the three elements and their interrelationships, and put them in their proper order. Beginning with the idea that no business exists without owning **something**, that most businesses owe something as well, and that Proprietorship is what is left over.

"Now, back to Debits and Credits. You buy a new piece of equipment. How's that going to be entered?"

"If I buy it for cash, my Cash account is credited for the purchase price. Then my Equipment account is debited for the same amount. Or, if I buy it on account, then I'd still debit Equipment, but I'd credit Accounts Payable."

"Good enough, Mike," Jim applauded. "Now, let's make it a little tougher. You had to pay sales tax and freight on the equipment you purchased. What now, student?"

"My guess is you'd break the Debit part down, with the actual cost of the item to go into the Equipment Account as a Debit. The tax and freight would go to the Expense account as Debits. And the total of the

Using Color-Bar and Crosshatch Patterns

by Carl Babcoke

Possible Sources of Trouble

Poor-quality TV pictures—displaced colors, ghosts and smearing, for example—can be caused by a defect(s) in the:

- receiver,
- antenna system,
- broadcast signal.

Eliminating The Receiver As a Source

To determine whether the receiver is the source of the trouble symptom(s):

- 1) disconnect the antenna from the receiver;
- 2) connect to the receiver antenna terminals a keyed colorbar generator;
- 3) visually check the quality of the crosshatch and color bars reproduced by the receiver. If no “distortions” are present, either the antenna system or the broadcast signal (or both) is the cause of the trouble symptom.

Analyzing The Receiver's "B-W" Capability

Preliminaries

Tune in a color program and adjust the brightness and contrast to normal levels.

Turn down the color control. (At this point, be sure convergence, including focus, is adjusted for sharpest picture detail, which does not necessarily coincide with sharpest raster lines.)

Disconnect the antenna. This is important because some antennas will cause ghosts and ringing when used with a color-bar generator.

Connect the color-bar generator to the antenna terminals.

Set up the generator to produce a crosshatch pattern. Also, turn on the generator sound carrier so that the receiver can be fine-tuned accurately.

Adjust the fine tuning toward the sound, until “beading” of the vertical bars is produced, as in Fig. 1.

Reverse the fine tuning enough to barely free the bars from beading.

Adjust brightness and contrast until the vertical white bars are not defocused and a faint raster can be seen between the bars (Fig. 2).

If convergence is poor, turn down two of the screen controls to leave just one color, preferably green.

Set any peaking controls to the medium or “normal” position.

Pattern analysis

Now you are ready to analyze the vertical bars. They should be sharp, of course, but more important are the black lines on the left and right of the “white” bars. The left black line doesn't give much indication of picture clearness, so devote most of your attention to the one on the right side.

Compare Fig. 2 with Fig. 3, in which the peaking control has been set for sharpest picture, or with Fig. 4, in which faulty fine tuning has caused the detail to

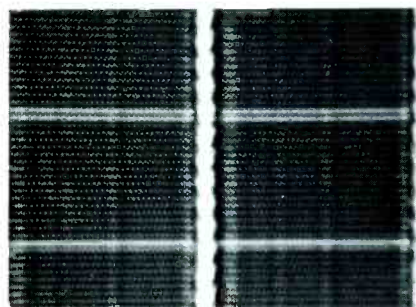

Fig. 1 Crosshatch pattern produced when the receiver is fine tuned too near the “sound bars”.

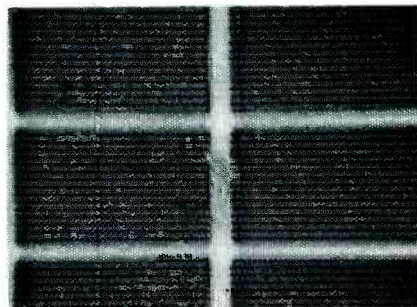

Fig. 2 Pattern produced when the receiver is tuned properly and the contrast and brightness levels are set correctly (raster lines visible).

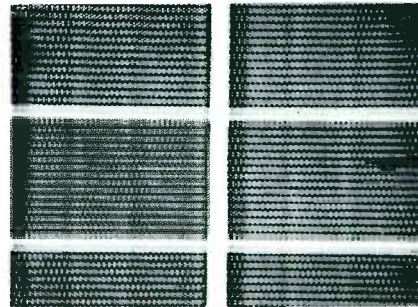

Fig. 3 Pattern produced when the peaking (or sharpness) control has been set to maximum position. Sharpness is exaggerated; note the darker, or shaded, area to the right of the white vertical bar in the center of the picture.

to Evaluate Color TV Performance

blur. It is easy to imagine the effect this latter symptom would have on station pictures.

Notice that the horizontal bars show little change. This is the reason we ignore them. Horizontal bars are affected by faults that alter low-frequency response in the IF and video chain. Low-frequency changes are less noticeable in most pictures than are high-frequency losses or ringing, so devote most of your attention to the vertical lines, which show effects on response at the high-frequency end of the video passband.

The preceding four illustrations show crosshatch patterns produced by a normal set with good alignment and detail; the differences pointed out represent various conditions of operation you might encounter during preliminary adjustment.

Fig. 5 shows one type of "ringing" which can occur if alignment is bad or if the IF's are close to oscillation. This particular condition was caused by an out-of-adjustment trap. Note the sharp white and dark vertical lines just to the right of the generator bar; these are typical of ringing. Ringing caused by misalignment will ordinarily vary with the fine tuning. The unwanted vertical lines will also appear differently for other types of misalignment. (Disregard the very faint white lines between the bars; these are traces from pulses that lock the divider chains in the generator.)

Method Also Can Be Used For B-W, With Exception

The method described here also can be used to eval-

uate monochrome receivers, with only one small precaution: Fig. 6 shows the ringing which might be produced by certain contrast-control settings in some models, particularly in sets that have a high-level control in the plate circuit of the video amplifier. Disregard this ringing if it disappears when you slightly reduce the contrast setting, because this will not happen on the station signal.

Testing Color Performance

If the receiver under test passed the previous visual examination, you can be certain the set is normal on that channel. Tuner misalignment can cause trouble on other channels, of course. You have analyzed the receiver from the antenna terminals, through the IF's and video stages, all the way to the picture-tube screen.

The preceding "monochrome" test, however, is no assurance of good color, because you have not checked the chroma circuit at all (remember, the color control was turned down). Trouble there can still prevent good color reception.

Overall color performance is analyzed in much the same way as the b-w performance, but by observing the quality of the **color bars** on the screen, not the cross-hatch.

You not only look for sharpness of the bars, but you also watch for unevenness of color across the total width of each bar and for edge-fringing of other tints.

First, reset the gray-scale tracking, if you changed it during the b-w analysis.

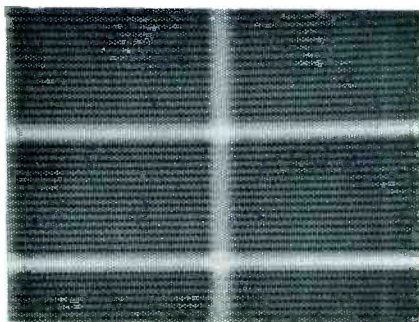

Fig. 4 Dullness of this pattern is caused by misadjustment of the fine-tuning control (away from the sound bars).

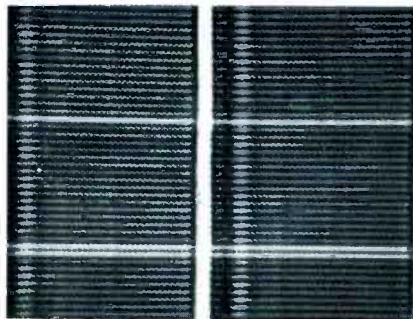

Fig. 5 Black-white-gray ringing at the right of the white vertical bar in the center of the picture is caused by misalignment.

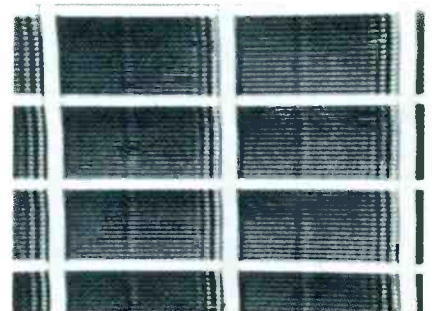

Fig. 6 Ringing produced at certain settings of the contrast control in some b-w sets is normal.

Set the generator to produce color bars of normal, or 100-percent, intensity. The sound carrier also should be on.

Tune in the generator signal as you would a colorcast from a station—by turning the color control up half-way, setting the fine tuning toward where the 920-KHz beat (clothlike pattern—see Fig. 7) is seen in the bars, then reversing the fine tuning enough to eliminate the beat.

Set the tint or hue control so the third bar from the left is maximum red.

Adjust the brightness and color controls until the bars have good color saturation without defocusing on the bright bars, and the background screen color can be seen easily between the bars. This background condition is important, because you are interested not only in the bars but in the spaces between them, where ringing, fringing, or smearing might be seen.

Convergence should be good, or “fringing” from that source might mislead you.

You can obtain the most information from a bar composed of more than one primary color, so watch the fourth bar from the left—the one that is supposed to be magenta or purple. Fig. 8 shows this bar on a normal receiver. Notice that the color intensity and tint of the bar are relatively even from edge to edge. The border on its right edge is caused partly by the generator and partly by slight video ringing in the receiver; this border is normal, so notice its width and intensity, for future reference.

Fig. 9 shows the monochrome (luminance) compo-

nent of the bars with the color control turned down. (The overall bluish-green cast is color distortion caused by the camera which took the photos. The same discoloring is visible between color bars in Fig. 8). To check chroma registration (how well the b-w and color pictures are superimposed over each other), turn the color control up and then down while noting how well the color component superimposes on the video. If the colors are sharp but displaced considerably to the right, suspect a shorted delay line. If the colors are displaced and also smeared, however, the alignment is off or the bandwidth has been reduced by some other cause, such as a component defect.

Fig. 10 shows the effect of a trap whose resonant point has been shifted into the IF bandpass curve. This is the same condition that produced ringing in the cross-hatch pattern in Fig. 5, but the effect is much more noticeable with color bars displayed. Notice that the magenta bar is now two-tone, and has a large smeary background border on the right. Remember that this type of change merely blurs the b-w picture, but causes wrong colors, as well as smeared colors, in a color program. This is the reason why correct alignment is so much more important in a color set.

Another type of misalignment, usually—but not necessarily—in the tuner, or even improper fine tuning, can produce the pattern in Fig. 11. These bars can be caused by chroma or IF misalignment. Notice that the magenta hue contaminates the third and fifth bars, and that the fourth bar is only partially magenta. Make sure, before you condemn alignment, that the fine tun-

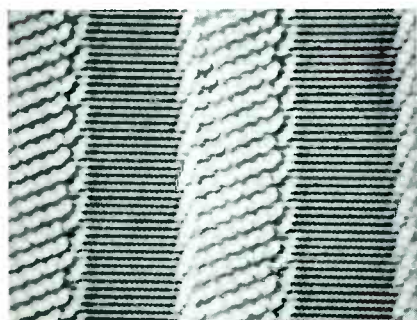

Fig. 7 Effect produced in a keyed-rainbow pattern when the fine tuning is “adjusted into” sound bars (920-KHz beat). No sound bars are produced when the generator sound carrier is turned off (see Fig. 12).

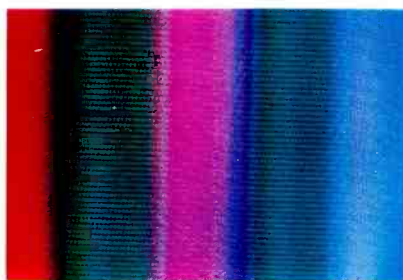

Fig. 8 Fourth color bar should be magenta. Adjust tint control, if necessary. Quality of the bars shown here is normal.



Fig. 9 With the chroma control turned down all the way, only luminance information is visible.

ing is set properly, because incorrect tuning also can cause this faulty pattern to appear.

Fig. 12 shows a b-w photo of the pattern in Fig. 7, except that the sound carrier has been turned off at the generator. The 920-KHz beat pattern between the 3.58-MHz subcarrier and the 4.5-MHz sound carrier is missing in Fig. 12. The exact slant of the bars will vary with the model of generator, so notice both patterns for later reference.

Precautions

1. Do not use any type of gun-killer switches during the preceding tests. Some gun killers smear only the color, while others smear both black and white and color.
2. Do not use extensions on the picture tube. Even a short extension can cause smear.
3. Do not have an antenna connected to the set at the same time that the generator is connected. At best, this will slightly blur the picture; at worst, it can cause a double image on black and white programs and excessive color shift during colorcasts.
4. Do not attempt an IF alignment by using this method. It should be used only to determine whether something is actually wrong with the set. A touch-up alignment might seem to be indicated, but misalignment is not always the cause; the

trouble could be caused by an open delay-line ground or a bad peaking coil.

Because you must depend on memory as a reference to what pattern to expect, the preceding analysis technique might seem a little vague and not very accurate. Yet it proves surprisingly exact, once you have learned to use it. With only a little practice you can look at each of the various patterns for a few seconds and determine the receiver's general condition, from the antenna terminals to the picture tube. All it takes is a color-bar generator, which you should take on every color TV service call. (Incidentally, the color-bar generator can be used to eliminate snow from the screen when you are making purity adjustments. It produces the same effect as removing a tube in the IF circuit. Simply display the dot pattern of the screen, and this will clear the screen of snow. Ignore the dots and set the purity adjustments to obtain an uncontaminated screen.)

Also, remember that various makes of dot/bar generators produce slightly different patterns, so, to perform the preceding tests and evaluations with the maximum possible accuracy and efficiency, you must be familiar with the normal output of **your** generator. The same model of generator (preferably, the same generator) must be used each time and under identical conditions. Obviously, you must use a generator that feeds the signal into the antenna circuit, because you should check the set from the antenna terminals to the picture tube, if the tests are to mean anything. ▲

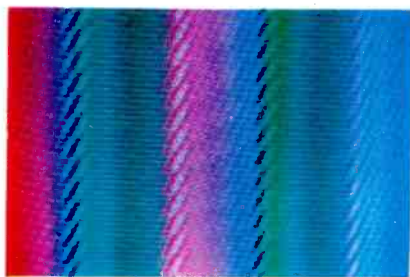

Fig. 10 A misadjusted trap causes ringing in video, and also causes changes in chroma response, including smearing and "uneven" color.

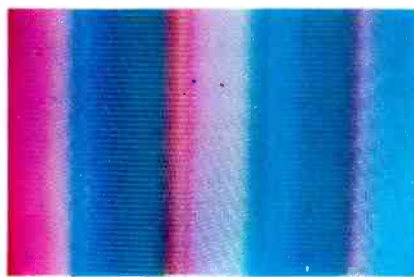

Fig. 11 Smearing caused by misalignment; such smearing also can be caused by incorrect fine tuning.

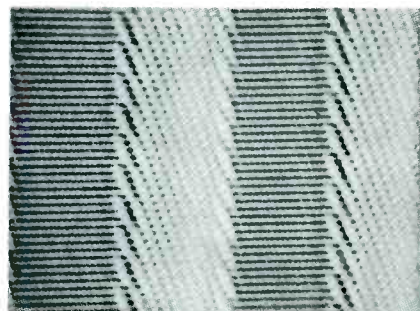

Fig. 12 Pattern produced when the receiver is tuned near the point where sound bars normally would be produced, but with the 4.5-MHz sound carrier switched off at the generator.

Troubleshooting motor circuits in auto tape players

Like the transistor portable radio market, the 8-track tape player market has been, more or less, captured by Japanese manufacturers. Consumers now can buy one of the less-expensive Japanese tape players for less than twenty dollars. Others range up to one hundred dollars. These low purchase prices mean that the serviceman's end of the business will be lost unless he can repair these imports efficiently and at low cost.

Toward satisfying that end, we are going to cover, in this and several future articles, the repair of tape players. The emphasis will be on automotive-type equipment, because it is the most commonly encountered. Both Japanese and American brands will be covered, as well as some of the more popular brands of in-home units. The particular areas covered in this article are speed problems and other troubles directly related to the motor circuit.

Test Setups

One of the most important facets of repairing tape players is an "efficient" bench setup. It is a good idea to have two speakers permanently mounted to the workbench. The voice coils should be accessible via quarter-inch phone jacks. Fig. 1 is a schematic of a setup I've found satisfactory; however, it is by no means the only, nor necessarily the best, way of wiring a tape-player/auto radio bench. If you can improve on the idea, by all means use your own version.

In my system, the jacks come out

to a panel on the bench. A universal set of speaker leads for use with this system consists of two alligator clips connected to a phone plug via a 3-ft. length of "zip" cord. Special sets of speaker leads for particular brands can be fabricated, if the volume of repair warrants. An example is shown in Fig. 2. The cable uses a 3-circuit (stereo) phone plug on one end and the almost-standard 5-pin tape player plug on the other. A "pin" view of this plug is shown in Fig. 2A. This particular harness will fit about 80 percent of the Japanese-type players. The plug is available from the parts departments of most importers or from many local parts wholesalers. You can also buy them from tape player retail outlets. The price at this last source, however, probably will be higher. Most plugs will come pre-wired, with about 1 ft. of lead attached to each pin. The standard Japanese color coding is:

- Speakers (green and gray)
- Power (red or blue)
- Ground (black and brown)

The speakers used on the bench should be heavy duty auto radio types. They can be mounted conveniently behind rear-seat speaker grills. A lesser-quality speaker probably will fail prematurely. Bench speakers are used more than most speakers mounted in cars. They also come in for a bit of unusual abuse, such as being accidentally connected across the 12-volt power supply (don't laugh... it happens more often than you probably imagine).

Types of Motor Circuits

A typical tape player motor circuit is shown in Fig. 3. This circuit, common in lower-priced imports, uses the so-called "2-wire" motor. The coil of the motor is connected in series with a set of switch contacts. The centrifugal force generated by the motor shaft causes the switch to open when a predetermined speed is reached. Because the actual operating voltage is less than the rated operating voltage of the motor (12 volts), the switch contacts will be continually opening and closing, to keep the motor speed relatively constant over a small range of RPM.

Excessive speed is one of the most common complaints about tape players using such circuits. It usually is caused by pitted governor contacts, which stick closed. This frequently can be cured by burnishing the contact faces. To be sure the problem does not recur after the contacts have been burnished, operate the unit for an hour or so.

One version of the 3-wire motor circuit is shown in Fig. 4. In this circuit the centrifugal governor is connected to an RC network. Be sure to check these external components before changing an expensive motor. If a component having the exact value of the original is not available, use the closest value possible. Be sure to adjust the value of the other component so that the original RC time constant is maintained. In any event, keep the component values as close to the originals as possible.

Fig. 5 shows a different config-

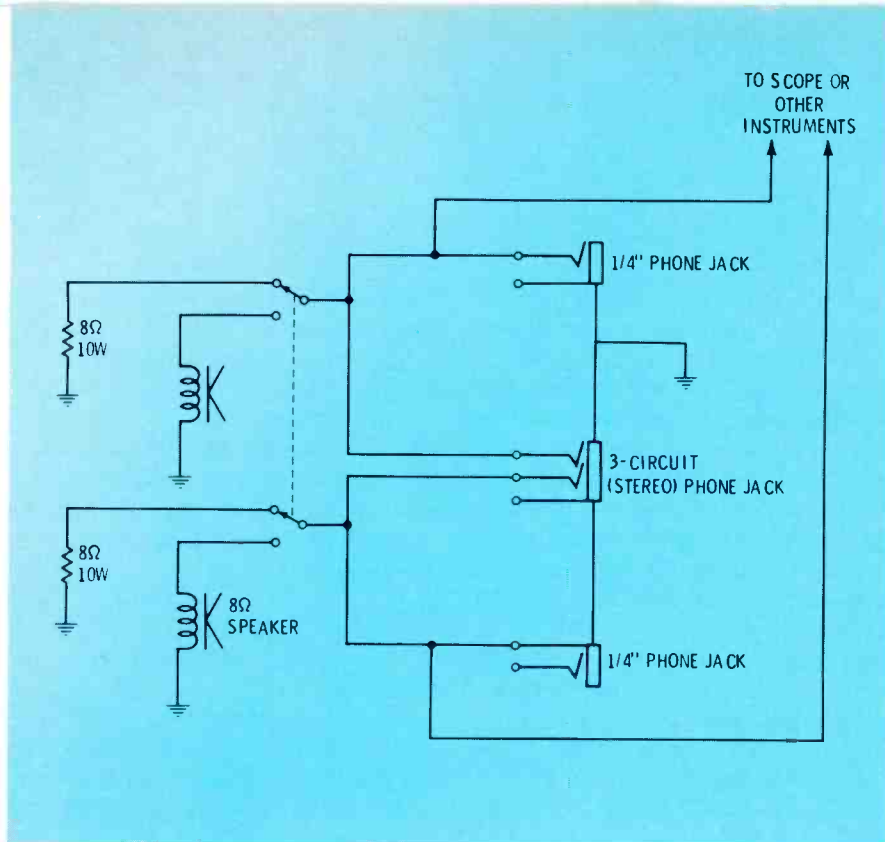

Fig. 1 Electrical connections for auto tape player test jig. The two speakers should be permanently mounted on the workbench, and should be heavy duty auto radio type. Phone jacks are mounted on a panel at the front of the bench.

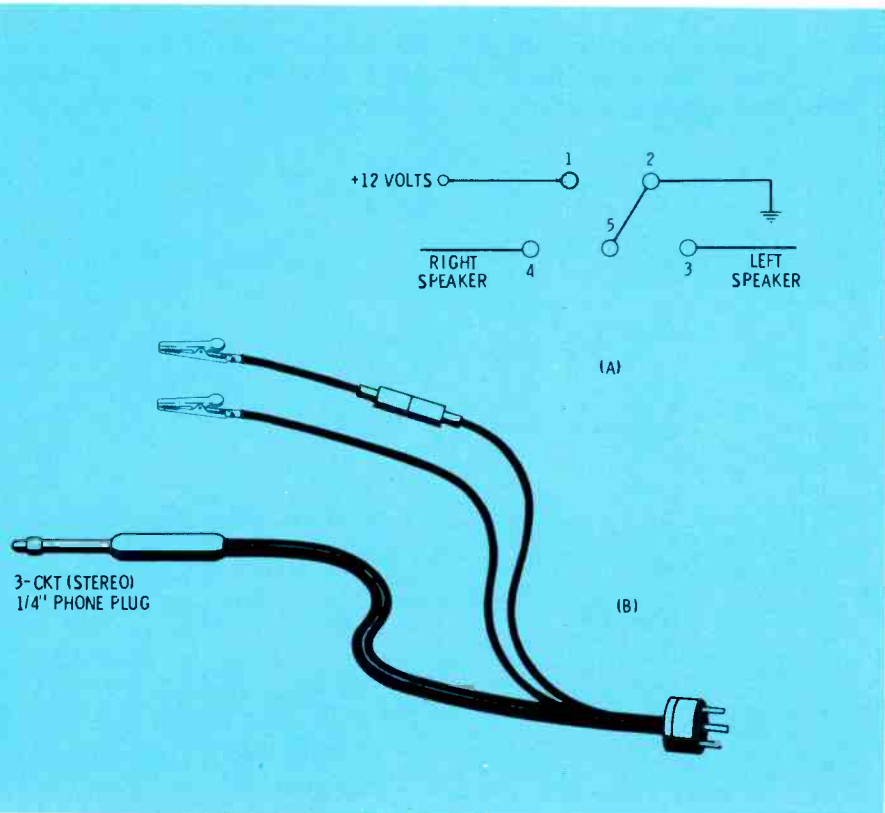

Fig. 2 Universal set of speaker leads for use with test system shown in Fig. 1. A) "Pin" view of plug. B) Drawing of speaker-lead set. Phone plug is 3-circuit (stereo) type. Plug on other end is 5-pin tape player type, used on most units.

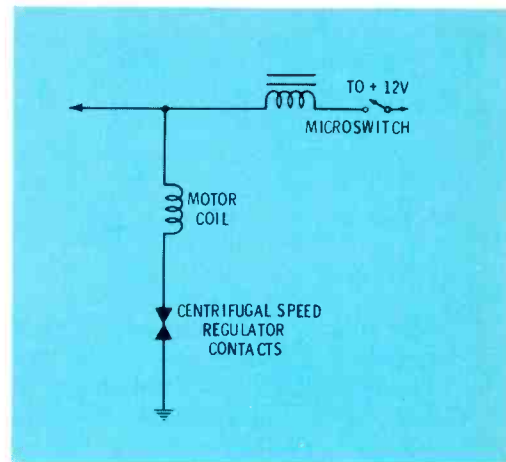

Fig. 3 Schematic diagram of "2-wire" motor circuit commonly used in lower-priced imported tape players. Excessive speed is one of most common troubles with this design, and usually is caused by pitted speed-regulator contacts, which stick closed.

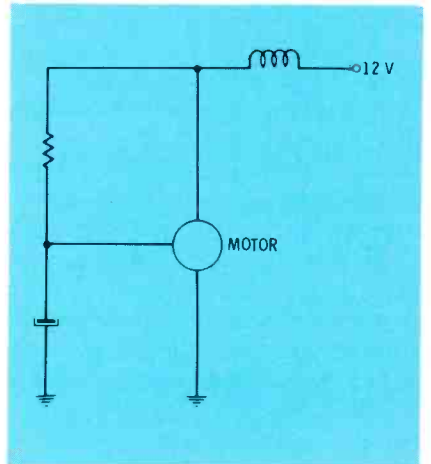

Fig. 4 One version of 3-wire motor circuit. Centrifugal governor is connected to an RC network, the values of whose components are critical.

uration of the 3-wire motor circuit. This particular design is used in earlier models of Motorola tape players. In this configuration a transistor is used to control the voltage supplied the motor. The governor contacts ground one of the resistors in the base bias network, which controls the conduction of the transistor.

If you encounter one of the very earliest Motorola players (circa 1966) with a bad motor, do not be surprised if the parts distributor gives you a replacement with a different part number and fewer wires. The old style motor has four wires,

the newer type has three. There will be instructions for circuit modifications packed with the motor. It also is worth noting that the 2N176 regulator transistor used in this unit is available from two sources. It can be purchased under Motorola part No. 48-134747 from local Motorola distributors. It also can be purchased under the "2N" number from most of the national mail-order houses which stock Motorola semiconductors.

Fig. 6 shows a later version of the same basic design shown in Fig. 5. It is used in Motorola TM711S and similar models. The circuitry is rearranged to permit the use of a lower-cost NPN silicon transistor (one of those plastic-case units). The transistor is installed on the underside of the motor regulator printed-circuit board.

The circuit in Fig. 7 is another variation of the same basic design. This circuit is used in Philips tape players made in Canada for Chrysler. It also uses a motor regulator transistor encased in plastic. In any tape player using plastic-case transistors, be sure that the screw hold-

ing the transistor is tight. If it is loose, the transistor will not dissipate sufficient heat, and the transistor probably will fail prematurely. It also might cause intermittent operation, if it is the grounding point for the circuit.

The circuit in Fig. 8 represents the "middle ground" in the continuing evolution of regulator circuits in Delco players. When Delco introduced the first T-200 series tape players, they used a circuit similar to that in Fig. 4. However, when they developed the "Slim-Line" T-400 series units, they switched to the circuit in Fig. 8.

In newer T-400's (late 1970 production), Delco uses an entirely different design. The new motor regulator circuit is shown in Fig. 9. Inside the motor case is an alternator whose shaft is "coupled" to that of the motor. The frequency of the alternator output voltage is proportional to the speed at which the shaft rotates. The AC output voltage is rectified by diode DS-31, and the resultant pulses are fed to the high-gain DC amplifier. The pulse repetition rate and the ampli-

tude of these pulses govern the operation of the DC amplifier. The DC amplifier, in turn, governs the motor speed, which, in turn, governs the pulse repetition rate, etc.

Now that we have taken a look at some of the more common motor circuits, let's turn our attention to procedures for servicing them.

Speed Tests

There are several methods for measuring the speed of a tape player. One method is a "beeper" tape. Such a test tape has a 60- or 120-Hz continuous tone on one side. It is punctuated every 59 seconds (one minute intervals) by 1000-Hz tone bursts of 1 second duration. A normally operating tape player will produce these bursts every 57-63 seconds. A watch with a sweep second hand or a stop watch can be used to measure the time between bursts. The author prefers a stop watch, because it leaves the technician free to answer the phone or perform other minor tasks while the test is being made.

Another option is to view the

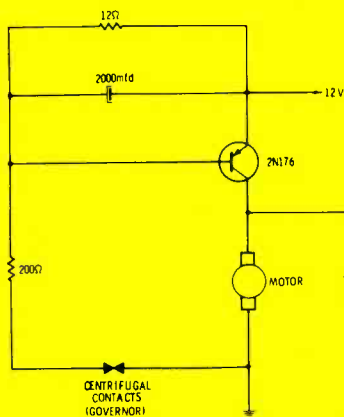

Fig. 5 Version of 3-wire motor circuit used in earlier models of Motorola tape players. Transistor regulates speed by controlling amount of voltage applied to motor.

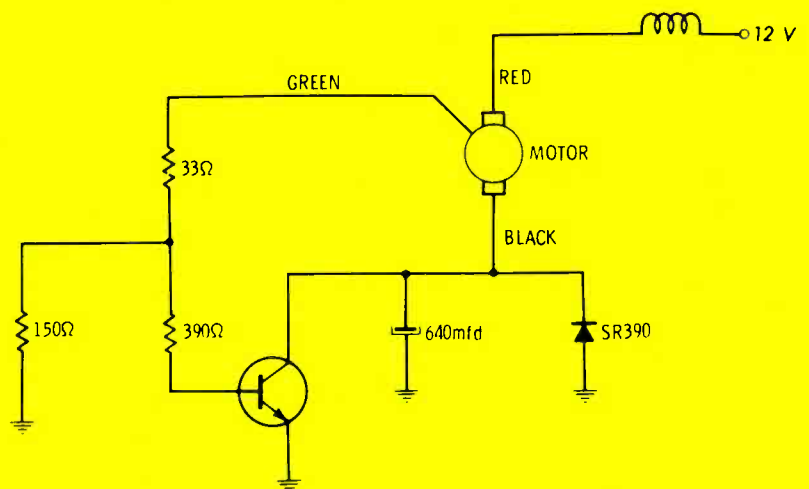

Fig. 6 Circuit shown here is later version of the basic design in Fig. 5, and is used in Motorola TM711S and similar models. The design is changed from that of the earlier version, to permit use of lower-cost, plastic-encased NPN silicon transistor.

60 Hz on a line-synchronized (60 Hz) oscilloscope. The trace will be a near circle, and will be steady when the speed is correct. One disadvantage of this method, however, is that almost all of these tape players exhibit "wow" (explained later in article). Also, the speed of these units might still be within tolerance even though the speed is far enough off to cause the scope trace to spin rapidly. Practice is required to interpret correctly the rotational speed of the trace.

Strobe cartridges for speed checks of both 8-track and cassette units recently have become available. These cartridges have a strobe pattern of alternating black-and-white stripes which run perpendicular to the length of the tape. A window and a neon bulb at the rear of the cartridge enable the technician to view the strobe action. Although this method also requires a little "interpretive" practice, it is easier to learn than the scope method.

One even newer method is to use a digital frequency meter to measure the frequency of a recorded tone. If the note happens to be 1000 Hz, the speed error can almost be read directly by noting the percentage of difference between it and what the counter shows (i.e., there is a 1-percent speed error for every 10 Hz of frequency difference). A short time ago this method would have been impractical because even a "cheap" digital frequency counter was priced beyond the range of most service shops. The recent introduction of less expensive digital frequency counters, such as the new Heath Model IB-101, might change all of that. There are, however, a couple of drawbacks to this method. One is the fact that the nature of a digital instrument (as opposed to the analogue types we are used to) makes continuous adjustments a bit difficult. Also, the level of signal on the tape must be high enough to prevent random noises and tape hiss from causing erroneous readings.

The speed troubles encountered in 8-track players can be divided

into three basic categories: too fast, too slow, and erratic (wow). The motor itself can be the cause in all three cases. It isn't, however, the cause of trouble in all cases.

If the motor does run fast, it probably will run **very** fast. The beeps on the test tape will run by every forty seconds or less. Do not let your test tape run too long at this speed; if you do, it might become stretched or might break.

The 2-wire motors usually run too fast because the governor contacts have stuck together. To test for this, lightly tap the motor housing with the handle of a screwdriver or similar tool while the player is operating. If the motor suddenly slows, you have found the trouble. A matchbook cover can be used to burnish the regulator contacts. Because the effects of burnishing don't always last long, it is good practice

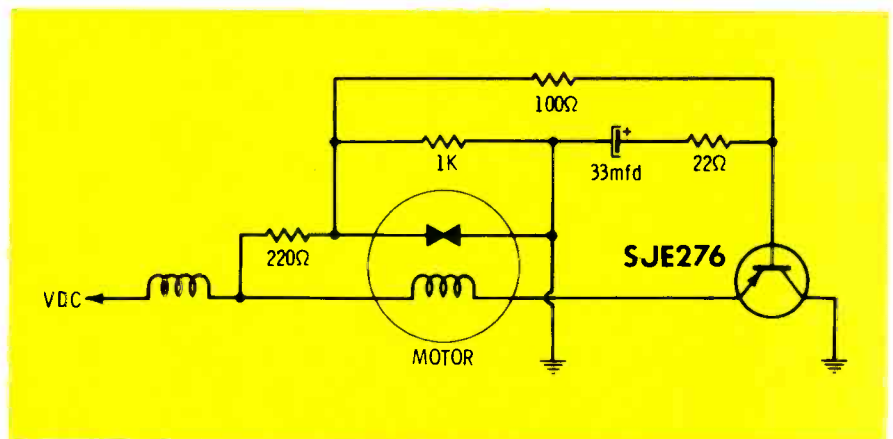

Fig. 7 Another variation of basic design on which circuits in Figs. 5 and 6 are based. Circuit shown here is employed in Chrysler tape players, made by Philips in Canada, and also uses plastic-encased speed-regulator transistor.

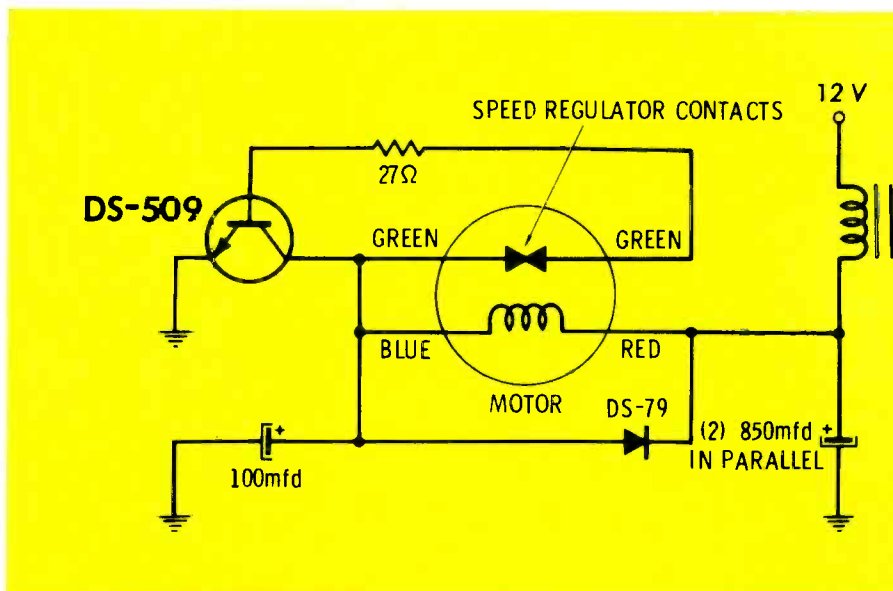

Fig. 8 Motor circuit used in Delco "Slim-Line" T-400 series tape players.

to allow the player to operate for awhile before returning it to the customer. If bench space is at a premium (where isn't it?), it might be better to replace the motor unit instead of attempting to repair the attached speed regulator circuitry.

Other causes of excessive speed are peculiar to motors with three wires. If a regulator transistor fails it might cause excessive speed. An open transistor will stop the motor. A shorted transistor, on the other hand, will cause the motor to run at an extremely excessive rate. A leaky transistor will cause the motor to run a little faster than normal; this is one of the few cases where the speed increase might not be drastic.

In circuits like that in Fig. 8, the electrolytic could short and cause excessive speed. A shorted diode in such a circuit will cause either slow speed or it will stop the motor altogether. (A shorted diode in the Motorola TM711S-type of circuit (Fig. 6), however, will cause the speed to increase.)

Dirt contamination

Slow running can be caused by several defects other than a defective motor. Dirt is one of the most common causes. Both foreign material and flaked oxide from the tape accumulate in the free space between the capstan and its housing. Fig. 10 shows two common methods of mounting the flywheel/capstan assembly. Dirt and oxide get into the tight spaces and on the bearing surfaces. There frequently is a lubricant (usually white grease) applied to the nylon tip bearings. When this lubricant mixes with the dirt, slow running is the result. To cure this condition, disassemble the flywheel/capstan and clean all dirt from the rim of the wheel, the running surface of the capstan, the bearings, and from inside the capstan housing. Use lighter fluid, alcohol, or any good solvent. Be absolutely sure to remove any residual fluid or it might cause trouble later. Also, be sure that any plastic parts

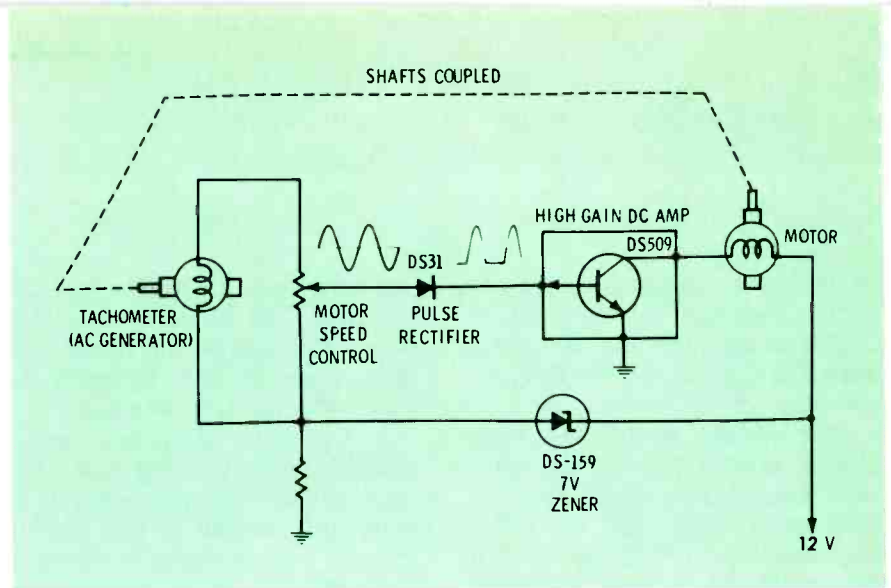

Fig. 9 Newer Delco motor regulator circuit, used in late 1970 production of T-400 tape players. Motor and AC generator are effectively on same shaft. See text for detailed explanation of operation.

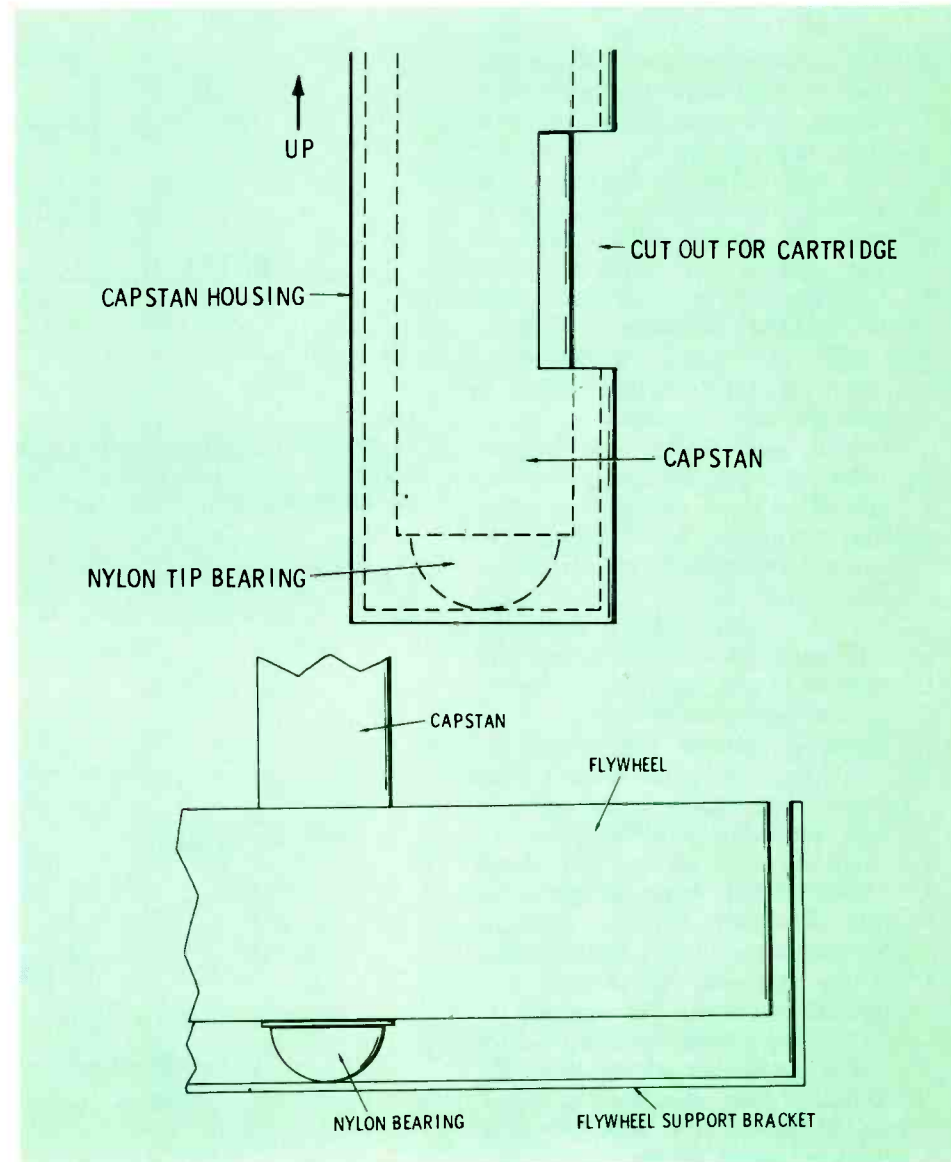

Fig. 10 Shown here are two common ways the flywheel/capstan assembly is mounted in tape players. Contamination of the bearings is one common cause of slow speed. See text for cleaning and lubricating instructions.

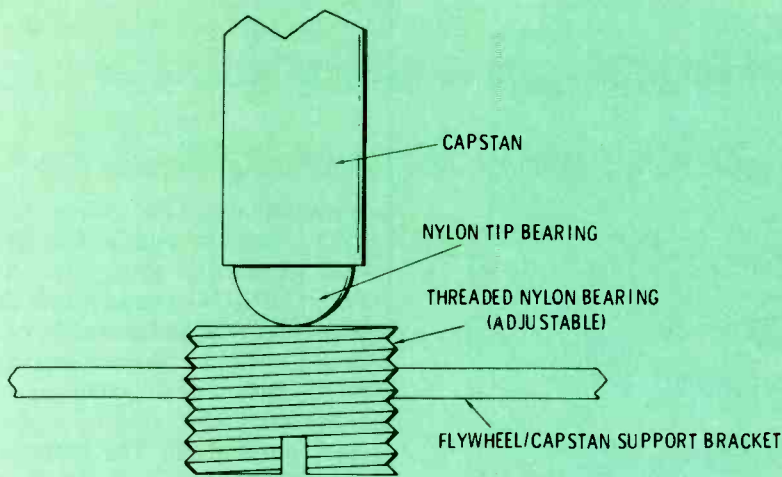

Fig. 11 Delco Model T-400 tape players use two nylon bearings in the flywheel/capstan assembly. As shown here, one is threaded so that its pressure against the nylon tip can be adjusted. If too much pressure is exerted by the threaded bearing, the speed of the player will be reduced.

are removed prior to cleaning. They might be damaged easily by strong cleaning solvents.

Improper lubrication

In any tape player, it is important to use lubricants very sparingly. A thin coat of white grease or one drop of a lightweight oil on the lower sleeve bearing or the nylon tip bearing will be sufficient. Any more at these points, or any at all on other surfaces, might foul the first several tape cartridges that are played (this includes your expensive test tape, because it probably will be the first tape played).

If the nylon tip bearing appears worn, it should be replaced. Some machines, especially the T-400 Delco players, have another nylon bearing threaded through the flywheel mounting plate (see Fig. 11). This bearing has a screwdriver slot so that its pressure against the tip bearing can be adjusted. If it is too tight it might cause sufficient drag to slow down the machine.

Another frequent cause of insufficient speed is dirt or grease on the belt surfaces of the flywheel and on the motor pulley. These points should be cleaned. Avoid touching these surfaces—even skin oils can cause the surface to become slippery.

Wow and flutter (erratic speed)

Wow and flutter form a third classification of speed troubles. Wow is almost the same as flutter, except for frequency. Wow is speed variations of about 1 Hz or slower. Flutter, on the other hand, is more rapid—3 to 12 Hz.

There are tape cartridge defects that can cause both wow and flutter. Be sure to check the machine with a known good cartridge. One common defect occurs when the user leaves a cartridge plugged in when the machine is turned off. This can dent the rubber pinch roller mounted inside the cartridge. The result is flutter or wow.

The nylon tip bearing is another source of wow in some Motorola tape players. If it is well worn, the capstan moves up and down, causing both varying speed symptoms and varying crosstalk. Because this bearing costs less than a dime, it is poor economy to risk a callback merely because you did not take time to replace it.

A worn flywheel drive belt can cause both slow running and wow problems. Relatively new belts frequently can be restored with phonograph drive wheel cleaner/rejuvenator. They also can be turned inside out, if both sides have a dull finish. The procedure doesn't seem to work

as well when one side of the belt is glossy. In any event, both of these are "make do" procedures. In cases of doubt, or on any machine that has seen either prolonged or exceptionally heavy use, it probably is wiser to sell the customer a new drive belt. A shop that does a lot of tape player servicing will find it profitable to stock most of the common sizes of belt. Many shops make it a habit to install all new rubber in all tape players brought in for service. These shops seem to have fewer speed-related callbacks.

Speed Adjustments

Some tape players have a motor regulator circuit that is adjustable. Some of them, such as early models of Learjet tape players, have a strobe pattern printed on the top of the flywheel. Others use a drive belt on which is printed the strobe pattern. Using these aids, it is relatively simple to properly adjust the speed. Merely view the strobe under fluorescent lights and turn the adjustment screw until the pattern is steady. On some of these units, it is necessary to practice a little patience and gain some practice, because the adjustment can be critical.

On types of machines not equipped with speed measuring devices, you can use either the strobe cartridge mentioned earlier or a line-synchronized (60-Hz) oscilloscope. If you use the scope method, merely adjust the speed (with a 60- or 120-Hz tape playing) until the pattern locks in and remains steady for several seconds. (Some long-term drift is to be expected, but it never should exceed the manufacturers specifications—usually plus or minus 2 percent.)

Now that we have discussed speed problems, it might be wise to say something about obtaining a replacement should the motor prove to be the problem. In most cases, a replacement motor unit can be ordered from the parts department of the manufacturer or importer. ELECTRONIC SERVICING annually publishes a source guide to

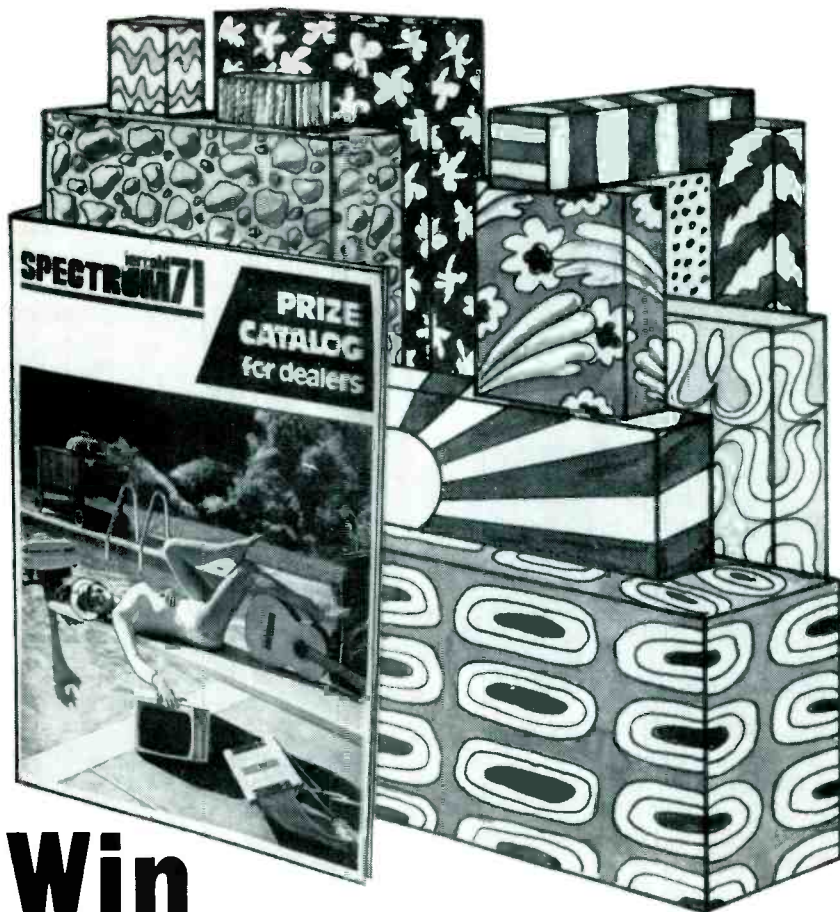

Win Fabulous Free Gifts

selling up to JERROLD antennas & systems

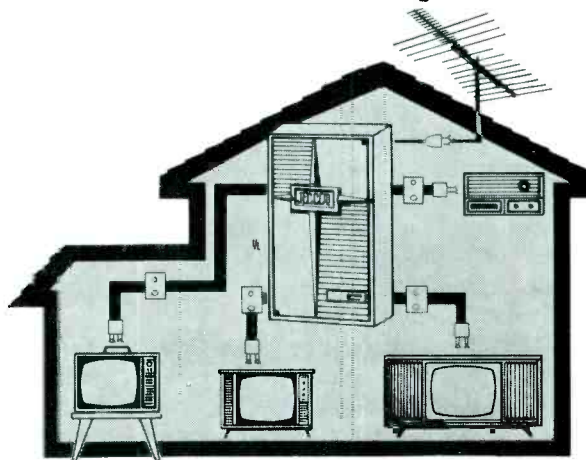

Spectrum '71 is designed to focus your attention on the broad spectrum of JERROLD high profit "better reception" products. When you sell up to the best in antennas and Master Antenna TV systems, you earn more profit . . . plus fabulous free gifts.

Ask your distributor for details on Spectrum '71 or write Jerrold Electronics Corporation, Distributor Sales Division, 401 Walnut Street, Philadelphia, Pa. 19105.



*Focusing on one thing...
better reception*

a GENERAL INSTRUMENT company

Circle 23 on literature card

imported sets. For some of the more common and a few of the less common sets, the Sam's PHOTOFACT Annual Index is the best source of addresses. In certain cases, however, the address might not be known or the company might either fail to respond or might not stock parts at all. The latter is frequently the case with small "post office box" companies which have sold only a few thousand, or even a few hundred, sets in a small region of the country. Even here, however, all is not lost. It might be possible to repair the old motor, or a motor from another brand might be adaptable. After servicing a few hundred Japanese motor circuits, you probably will notice a striking similarity in the motors of the many different brands. It almost seems that only two or three Japanese firms make motors for all of the tape player manufacturers.

If you have a stock of motors from one of the larger importers, such as Automatic or Craig, it is a relatively simple matter to select one that is easy to adapt. First, pick out those which have DC resistances close to that of the original. Also, separate those which have the same direction of rotation as the original. (This can be determined by connecting the red wire from the motor to the positive side of a 12-volt supply. Connect the blue wire to the negative terminal of the supply.) Do not attempt to use a motor designed for opposite rotation than desired by reversing the leads. This makes the motor sound "ragged", and can cause premature failure.

If the motor speed is wrong, try changing the pulley on the motor shaft. In fact, it is wise to save the "hardware" from tape players that are either junked or abandoned. Save the "junk" motors for the inevitable slow day, on which your RNR man or the shop apprentice has little to do . . . let him earn part of his keep by stripping these "junkers." ▲

test equipment report

Miniature Transistorized AC Bridge

A transistorized, universal AC bridge that measures resistance, inductance, capacitance and winding ratios of transformers has been introduced by the C. H. Mitchell Co.

Specifications are: Resistance range, 0.1 ohms to 11.1 megohms; inductance range, 1 microhenry to 111 henries; capacitance range, 10 picofarads to 1110 microfarads and a winding ratio range of 1/10000:1 to 11100:1. Internal frequency is 1KHz.

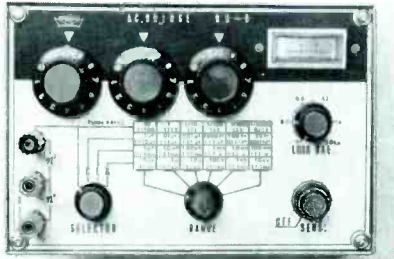

The AC bridge measures 5 inches x 7 1/8 inches x 3 inches and weighs 2 1/4 lbs. The price is \$60.00.

Circle 50 on literature card

Compact VOM

The RCA WV-518A is a compact multimeter which features a mirror-scale to avoid parallax errors when reading critical measurements, and has a convenient panel-mounted fuse to protect the ohms divider resistors from accidental burn-out. A switch on the front panel selects functions and ranges.

This instrument measures DC voltages from 0.01 to 500 volts; AC voltages (rms) from 0.5 to 500 volts; DC current from 10 microamperes to 500 milliamperes; and resistance from 1 ohm to 2 megohms. The sensitivity of the WV-518A is 20,000 ohms-per-volt for DC measurements, and 10,000 ohms-per-volt for AC measurements.

The unit measures 5 1/8 inches x 3 1/2 inches x 1 7/8 inches, weighs 1



lb. and is supplied complete with test leads and two 1.5-volt penlite batteries. The price is \$28.50.

The RCA WG-297 High-Voltage Probe, with the WG-422A Multiplier Resistor, can be used with the WV-518A VOM to measure voltages up to 50 kilovolts.

Circle 51 on literature card

DC- to 25-MHz Dual-Trace Triggered Scope

Hickok has announced a dual-channel scope with a vertical bandwidth from DC to 25 MHz (-3 dB point). Other features of Model 5002 include a built-in vertical delay line which provides 50 ns of display prior to the trigger point on

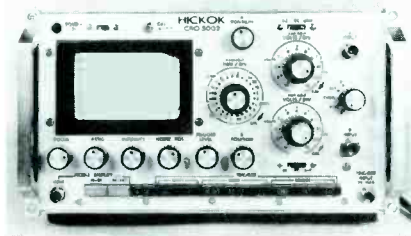

the input waveform. The triggering circuit reportedly provides solidly-locked waveform displays beyond 50 MHz. Either the positive or negative slope of the input waveform may be selected to start the sweep; from the internal source, the sweep will trigger on a waveform as small as 0.2-division deflection.

Model 5002 reportedly has 3-percent calibrated vertical sensitivities from 10 mV to 20 volts per division in a 1, 2, 5 sequence. Input impedance is 1 megohm, 30 pf.

pliers pliers pliers



ALL THE TYPES YOU NEED IN A FULL RANGE OF SIZES.

From 4" miniature electronics to 10" utility. Precision made in USA. Forged alloy steel construction. Cleanly milled, perfectly aligned jaws. Hand-honed, mated cutting edges. Most with Cushion Grip handles.

NOW INCLUDING

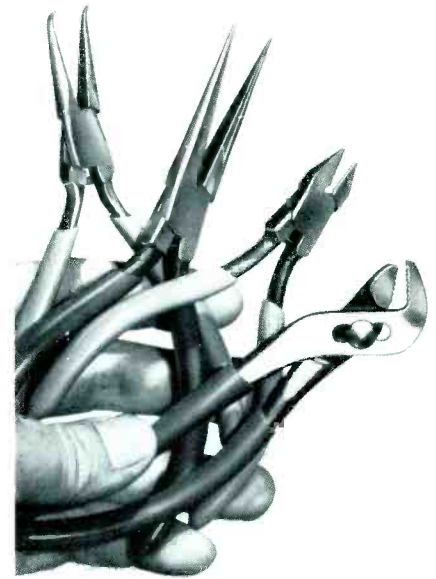

- 5" Bent Thin Chain Nose. For handling fine wires in close quarters. No. 79CG
- 5 1/2" Thin Needle Nose. For firm gripping and looping of wires. No. 57CG
- 4" Full Flush Cutting Diagonals. Snap cuts to the extreme tip. No. 84CG
- 5" Midget Slip Joint. Narrow jaws for close quarter work. 3 openings to 1/2". No. 50CG

REQUEST CATALOG

nationwide availability through local distributors

XCELITE

XCELITE, INC., 18 Bank St., Orchard Park, N. Y. 14127
In Canada contact Charles W. Pointon, Ltd.

Circle 24 on literature card

Overload protection is 500 volts on all but the most sensitive range, on which it is 300 volts. Rise time is 14 ns.

The "overdrive" characteristic of the vertical output section reportedly facilitates detailed, critical viewing or measurement of the waveform. The vertical amplitude of any waveform may be increased to three times screen height without increasing distortion, according to the manufacturer.

Bandwidth of the horizontal amplifier is from DC to 5 MHz. Sweep

speeds range from 50 ns to 2 seconds per division in a 3-percent calibrated 1, 2, 5 sequence. It also provides continually variable sweep speed between ranges.

A sweep delay circuit allows display of any 10-division segment of the 40-division sweep—a signal may be viewed in detail up to 40 divisions after the trigger point. Sweep linearity reportedly is maintained throughout the entire sweep range.

The Hickok 5002 Oscilloscope measures 6 $\frac{7}{8}$ inches x 11 $\frac{1}{4}$ inches x 19 inches, including handles, and

weighs 24 lbs. It reportedly can be used as a bench instrument or can be rack mounted.

Price is \$995.

Circle 52 on literature card

Six-Digit Frequency Counter

A new general purpose, six-digit electronic counter has been announced by Simpson Electric Company.

The new counter, Model 2726, provides numeric displays of frequencies from 5 hertz to 32 megahertz in six switch-selectable time bases. Period measurement (single and multiple) plus frequency ratio (referenced to 1, 10, 100 or 1000 cycles of the base frequency) can be made with this versatile instrument. Additional capabilities include

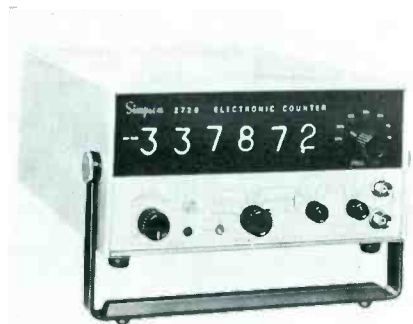

time-interval measurement and pulse totalizing.

Automatic over-range capability provides 9-digit resolution allowing even 10 MHz signals to be read to 0.1 Hz. A red light on the front panel indicates when the counter is in an over-range condition.

Front panel controls include time-base switch, function-select switch, manual start-stop toggle, and an On/Off display control potentiometer. Display time is adjustable from five readings per second to "hold".

An internal crystal control clock insures accuracy of 0.001% over a temperature span of +15 to +55 degrees C.

Options include BCD output, rear panel input connector and a hardware kit for rack mounting. For applications where increased accuracy is required, a rear panel mounted BNC connector provides input for an external precision oscillator.

The formed metal case measures 4 inches x 8 $\frac{1}{4}$ inches x 11 inches. Input voltage requirements are 115 or 220 volts AC 50-60 Hz.

HERE'S YOUR OPPORTUNITY TO SUBSCRIBE TO RCA SERVICE DATA

COVERING CURRENT MODEL RCA CONSUMER ELECTRONIC PRODUCTS



A SUBSCRIPTION INCLUDES
A COMPLETE "FILE" YEAR OF:

- COLOR TELEVISION DATA
- B & W TELEVISION DATA
- RADIO DATA
- PHONOGRAPH DATA
- TAPE RECORDER DATA
- SERVICE TIPS
- PARTS TIPS
- PERIODICAL ISSUES OF "PLAIN TALK"
- "GOLDENROD" BULLETINS

DON'T DELAY!
ORDER YOUR SUBSCRIPTION
TODAY!

Please acknowledge my request for a Service Data Subscription:

- "File—1971" Service Data including 2 binders \$19.95
 "File—1971" Service Data subscription \$14.95
 (Binders available separately—\$2.95 each) Number desired _____

Amount enclosed: \$ _____

NAME _____

STREET ADDRESS _____

CITY _____

STATE _____

ZIP CODE _____

- Your order will be processed promptly upon receipt of your check or money order in the amount indicated above. SEND TO:

RCA SALES CORP., 600 N. Sherman Drive, Indianapolis, Ind. 46201
ATTN: Technical Publications, 8-106.

Model 2726 is priced at \$575. A 5-digit counter, Model 2725A is available for \$525.

Circle 53 on literature card

IC Regulated Power Supply

The use of an integrated circuit (IC) regulation system, which results in the elimination of over 30 discrete components and significantly reduces both the size and weight of the unit, is a feature of Model LL-902-OV power supply, according to the manufacturer, Lambda Electronics Corp.

An automatic electronic current-limiting circuit reportedly limits out-



put current to a preset value, providing protection for the load as well as the power supply. Adjustment of voltage control allows the overvoltage protection circuit to automatically track the output voltage.

Operating features include: 0-20 volt current ranges, with current ranges of 1 ampere; line regulation of 0.01% +1 mv; ripple of 250 μ v rms, and an AC input of 105-132 VAC, 47-440 Hz, based on a 57-63 Hz.

Model LL-902-OV measures 5 $\frac{5}{8}$ inches x 5 $\frac{1}{2}$ inches x 3 $\frac{3}{8}$ inches, weighs less than 6 lb., and sells for \$99.00. ▲

Circle 54 on literature card

Moving?

Send your new address to:

ELECTRONIC SERVICING

Circulation

1014 Wyandotte St.

Kansas City, Missouri 64105

The inside story of Tuner Sprays

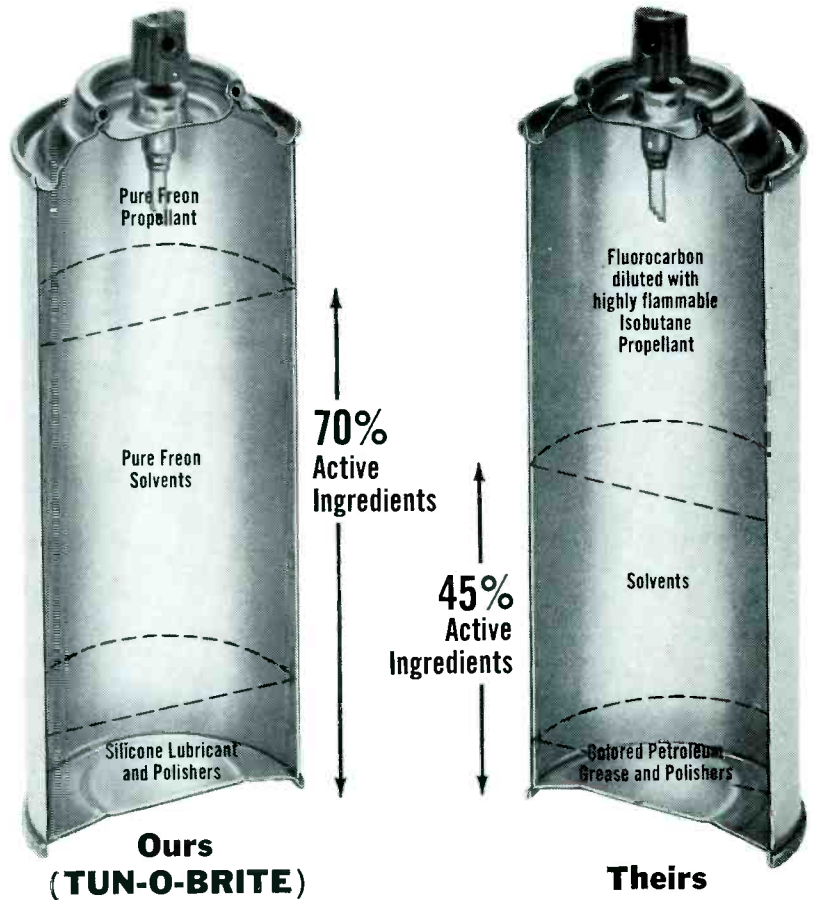

**Ours
(TUN-O-BRITE)**

Theirs

Ever wonder, with all the brands and conflicting claims, is there a difference?

All tuner sprays contain active ingredients. To clean. Lubricate. Polish. Quantity and kind of ingredients are what make the difference.

What's so different about TUN-O-BRITE? Chemtronics uses only special blends of Freon*. The very best cleaning solvent, and at the same time, one of the most efficient propellants for aerosols. Non-flammable too. A little goes a long way. And TUN-O-BRITE contains more of it.

No wonder servicemen find they **double the number** of tuners they clean with TUN-O-BRITE.

What about the lubricant? Chemtronics uses only non-evaporating silicones. Stable. Also non-flammable. Last longer.

For polishing ingredients, Chemtronics formulated a microscopic, hollow-core particle. Like a bubble it disintegrates after the initial wiping action of the tuner. Polishes without wearing away precious metal plating.

Prove it to yourself. Spray TUN-O-BRITE on a paper and rub it. Feel the initial grittiness? Now rub again. Abrasiveness disappears. This safe polishing action is unique with TUN-O-BRITE.

There's no mystery to a good tuner spray. How do you tell if quality ingredients or low-grade substitutes are being used?

Read the label. Does it say "non-flammable"? It should. Are there directions for a clogged nozzle? If a lubricant will dry and cake in the nozzle, think what it will do on your contacts. Try the "abrasion test."

Or, to be sure buy TUN-O-BRITE.

CHEMTRONICS INC.

1260 Ralph Avenue, Brooklyn, New York 11236

AT NEW SHOW, VISIT OUR BOOTH A-129, HOSPITALITY SUITE 1052, AMERICANA HOTEL

*Trade name of E. I. Dupont

Circle 25 on literature card

Tube Usage in 1970

Listed here, in alpha-numerical order, are 637 receiving tubes which, according to General Electric, were used more than other tubes in 1970. Beside each type is a number which, when multiplied by 10,000, is General Electric's estimate of the usage of that tube in 1970.

Type	Quantity	Type	Quantity	Type	Quantity	Type	Quantity	Type	Quantity		
OZ4/OZ4A	17	4HM6	2	6AU5GT	2	6CK4	1	6GW8/ECL86	18	6MN8	6
1AD2A	9	4HS8	6	6AU6A	53	6CL6	7	6GX7	11	6MQ8	2
1AY2	3	4JC6A	9	6AU8A	11	6CL8A	25	6GY5	2	6MU8	1
1BC2	18	4JD6	4	6AV5GA	2	6CM3	3	6GY6/6GX6	61	6MV8	1
1G3GTA/1B3GT	56	4KE8	7	6AV6	17	6CM6	2	6H6	3	6N7	2
1K3A/1J3	48	4LJ8	3	6AW8A	79	6CM7	15	6HB5	4	6S4A	7
1R5	4	5AM8	2	6AX3	7	6CM8	1	6HB6/6HA6	1	6SC7	3
1S2A/DY87	3	5AN8	1	6AX4GTB	36	6CN7	3	6HB7	39	6SF5	1
1U4	3	5AQ5	10	6AX5GT	3	6CQ8	6	6HD7	1	6SH7	1
1U5	3	5AR4/GZ34	7	6AY3B/6BS3A	38	6CS6	5	6HE5	22	6SJ7	8
1V2	62	5AT8	1	6AZ8	2	6CS7	5	6HF5	11	6SK7	3
1X2C/1BX2	22	5BC3A	2	6B10	12	6CU5	12	6HF8	10	6SL7GT	10
2AV2	64	5BK7A	1	6BA6/EF93	21	6CU8	3	6HG8/ECF86	4	6SN7GTB	34
2BN4A	2	5BZ7/5BQ7A	1	6BA8A	2	6CW4	13	6HJ8	1	6SQ7	3
2BU2/2AS2A/2AH2	5	5CG8	12	6BA11	31	6CW5/EL86	11	6HL8	2	6T8A	9
2CW4	2	5CL8A	4	6BC4	1	6CX8	9	6HM5/6HA5	88	6T10	14
2CY5	7	5EA8	5	6BC8/6BZ8	5	6CY5	10	6HQ5	33	6U8A/6AX8/6KD8/5KD8	74
2DZ4/2AF4B	3	5EW6	4	6BD11	1	6CY7	3	6HS5	25	6U9	1
2FS5	3	5FG7	3	6BE3	5	6CZ5	6	6HS6	1	6U10	23
2GK5/2FQ5A	9	5FV8/5BR8	2	6BE6	15	6DA4A/6DM4A	2	6HS8	27	6V3A	1
2HQ5	1	5GH8	33	6BF6	1	6DB5	1	6HV5	19	6V6	4
3A3C/3AW3/3B2	221	5GJ7	9	6BF11	2	6DC6	3	6HZ6	42	6V6GTA	23
3AT2B	43	5GM6	4	6BG6GA	1	6DE4/6CQ4	17	6J5	4	6W4GTA	1
3AW2A	5	5GS7	6	6BH6	19	6DE6	5	6J6A	9	6W6GT	6
3BN6	2	5GX7	5	6BH8	2	6DE7	5	6J7	3	6X4	18
3BU8/3GS8	3	5HZ6	3	6BH11	9	6DG6GT	2	6JB6A	30	6X5GT	8
3BW2/3BS2A/3BT2	3	5JK6	1	6BJ6	12	6DK6	9	6JC6A	85	6X8A	17
3BZ6	15	5KE8	18	6BJ8	4	6DL5/EL95	1	6JC8	3	6X9/FCF200	7
3CA3	9	5KZ8	2	6BK4C/6EL4A	191	6DN7	6	6JD5	2	6Y6GT	1
3CB6/3CF6	6	5LJ8	18	6BK5	1	6DQ5	30	6JD6	17	6Y9	3
3CE5/3BC5	6	5MB8	5	6BK7B	11	6DQ6B/6GW6	90	6JEC6/6LQ6	202	6Z10/6J10	29
3CN3B	9	5T8	1	6BL7GTA	4	6DR7	11	6JE8	1	7AU7	3
3CS6	2	5U4GB/5AS4A	90	6BL8/ECF80	76	6DS4	15	6JF6	15	7C5	2
3CU3A	45	5U8	11	6BM8/ECL82	18	6DT5	2	6JG6A	5	7G5	2
3CY5	2	5V3/5AU4	2	6BN4A	6	6DT6A	26	6JH6	37	7F7	2
3CZ3	15	5V4GA	2	6BN8	9	6DT8	2	6JH8	11	7GS7	2
3DB3/3CY3	15	5X8	1	6BQ5/EL84	30	6DX8/ECL84	53	6JM6	23	7HG8/FCF86	4
3DC3	9	5Y3GT	25	6BQ6GTB	16	6DZ4/6AF4A	17	6JN6	14	7N7	2
3DJ3	18	6AB4	5	6BS8	1	6E5	1	6JN8	5	8AR11	2
3DK6	3	6AC7	2	6BU8	19	6EA8	163	6JQ6	3	8AW8A	12
3DT6	4	6AC10	6	6BV11	3	6EH4A	3	6JS6C	102	8B10	11
3DZ4/3AF4B	4	6AD10	5	6BW4	1	6EH5	4	6JT6A	5	8BA11	6
3FS5	1	6AF3	5	6BW8	2	6EH7/EF183	22	6J78	25	8BM11	1
3GK5	38	6AF4	9	6BW11	5	6EH8	2	6JU8A	74	8BQ5	2
3HM5/3HA5	23	6AF9	3	6BX7GT	2	6EJ4A	2	6JW8	2	8BQ11	2
3HQ5	13	6AF11	8	6BY6	3	6EJ7/EF184	60	6JW8/ECF802	110	8BU11	2
3HS8	1	6AG5	3	6BY8	3	6EM5	15	6JZ8	8	8CS7	3
3JC6A	4	6AG7	2	6BZ6	99	6EM7/6EA7	43	6K6GT	7	8CW5	4
3KT6	3	6AG9	6	6BZ7/6BQ7A	20	6ER5	4	6K11/6Q11	1	8FQ7/8CG7	88
3V4	3	6AH4GT	1	6C4	14	6ES5	2	6KA8	40	8JU8A	6
4AU6	2	6AH6	5	6C5	1	6ES8/ECC189	5	6KD6	41	8JV8	9
4BC8	2	6AH9	1	6C9	2	6EU7	9	6KE8	42	8KA8	4
4BU8/4GS8	1	6AK5/EF95	13	6CA4	4	6EU8	2	6KM6	21	8KR8	1
4BZ6	31	6AK6	8	6CA5	1	6EV5	7	6KN6	10	8LC8	2
4BZ7/4BQ7A	3	6AL3/EY88	15	6CA7/EL34	7	6EW6	66	6KR8	3	8LT8	12
4CB6	6	6AL5	24	6CB5A	3	6EW7	8	6KS6/6BN6	14	9A8/8A8/PCF80	7
4CS6	3	6AL11	4	6CB6A/6CF6	52	6EZ8	9	6KT6	4	9AH9	1
4DK6	1	6AM8A	11	6CD6GA	11	6F6	3	6KT8	78	9AU7	2
4DT6	7	6AN8A	16	6CE5/6BC5/6CG3/6CE3/6CD3	28	6FD7	2	6KV6A	1	9AU7	2
4EH7	13	6AQ5A/6HG5	92	6CG8A	83	6FG7	15	6KV8	3	9GH8A	1
4EJ7	12	6AQ8/ECC85	6	6CH8	1	6FG7A	118	6KY8A	12	10CW5/LL86	13
4GK5	4	6AR11	4	6CJ3/6DW4B/6CL3	228	6GF7A	2	6KZ8	60	10DE7	14
4GX7	1	6AS5	9	6CK3	2	6GH8A	681	6L6	5	10DX8/LCL84	8
4HA5/PC900	2	6AS8	4	6CN11	6	6G5	5	6L6GC	31	10EG7	3
		6AT6	4			6GE5	20	6LB6	50	10EW7	1
		6AT8A	1			6GF7A	2	6LC8	2	10GF7A	3
		6AU4GTA	21			6GH8A	2	6LE8	13	10GK6	9
						6GJ5A	2	6LF6	3	10GN8	4
						6GJ7/ECF801	35	6LFB	26	10HF8	4
						6GK5/6FQ5A	25	6LJ6A/6LH6A	3	10J78	8
						6GK6	18	6LJ8	24	10JY8	6
						6GL7	2	6LM8	29	10KR8	3
						6GM6	41	6LN8	11	10T10	1
						6GM8/ECC86	16	6LQ8	4	10Z10	1
						6GN8/6EB8	34	6LR6	5	11AF9	4
						6GS7	2	6LT8	12	11AR11	2
						6GT5A	2	6LU8	17	11BM8	3
						6GU7	83	6LX8/LCF802	4	11BQ11	4
						6GV5	7	6LY8	38	11BT11	4
								6M11	5	11F7	4
								6MB8	3	11HM7	5
								6MD8	13	11JE8	1
								6ME8	9	11KV8	15
								6MF8	1	11LQ8	5
								6MG8	2	11LT8	1
								6MJ8	3	12AB5	5
								6MK8A	1	12AD6	6

Type	Quantity	Type	Quantity
12AE6A	5	17CK3	2
12AE10	7	17CT3	3
12AF3	1	17CU5/17C5	3
12AF6	1	17D4/17DM4A	2
12AL5	2	17DE4	2
12AL11	1	17DQ6B/17GW	9
12AQ5	5	17DW4A	1
12AT6	4	17EW8/HCC85	1
12AT7/ECC81	45	17GJ5	1
12AU6	19	17GT5A	4
12AU7A/ECC82	30	17GV5	1
12AV5GA	3	17JB6A	16
12AV6	30	17JM6	7
12AV7	18	17JN6	8
12AX3	1	17JT6A	2
12AX4GTB	11	17JZ8	50
12AX7/ECC83	27	17KV6A	1
12AX7A/7025	65	18GB5	2
12AZ7A	12	19AU4GTA	1
12B4A	7	19CG3	3
12BA6	29	19HV8	1
12BE3	3	19T8	4
12BE6	51	20AQ3/LY88	8
12BF6	1	21GY5	23
12BF11	2	21HB5A	5
12BH7A	24	21JS6A/23JS6A	5
12BL6	4	21JZ6	6
12BQ6GTB	1	21KA6	2
12BR7	2	21LG6A	2
12BW4	1	21LR8	14
12BY7A/12BV7/12DQ7	45	21LU8	5
12CA5	3	22BH3A	2
12CU5/12C5	6	22BW3	11
12D4	2	22DE4	5
12DB5	1	22JF6	15
12DQ6B/12GW6	10	22JG6A	9
12DS7	2	22IR6	9
12DT5	3	22JU6	8
12DT8	7	22KM6	5
12DW4A	2	23Z9	30
12EK6/12DZ6/12EA6	2	24JZ8	2
12FX5	8	24LQ6/24JE6C	3
12GE5	3	25AV5GA	2
12HG7/12GN7	27	25C5	9
12HL7	16	25CD6GB	1
12J06	4	25CG3	3
12MD8	2	25DN6	1
12R-K19	12	25EH6	2
12SA7	2	25L6GT/25W6GT	2
12SJ7	1	26HU5	1
12SK7	2	27GB5/PL500	2
12SL7GT	2	30AE3	1
12SN7GTA	5	30JA6	1
12SQ7	3	30KD6	1
12TI0	3	31JS6A	1
12V6GT	1	32ET5A	1
12W6GT	1	33GT7	2
12X4	2	33GY7A	29
13CW4	2	34CE3/34CD3	7
13DE7	2	35C5	18
13DR7	7	35EH5	1
13EM7/15EA7	8	35L6GT	2
13FD7	3	35W4	54
13GF7A	20	35Z5GT	20
13V10	2	36AM3A	2
13Z10/13J10	3	36KD6/40KD6	15
14BL11	3	38HE7	31
14BR11	1	38HK7	9
14GT8	1	42KN6	12
15AF11	1	50C5	86
15BD11A	4	50DC4	2
15CW5/PL84	8	50EH5	12
15DQ8	1	50HK6	4
15FM7/13FM7	3	50L6GT	8
15KY8A	26	60FX5	1
15MF8	1	5879	7
16A8/PCL82	2	6267	1
16AQ3/XY88	7	6973	8
16GK6	1	7027A	5
17AB10/17X10	1	7189A	5
17AX3	1	7199	8
17AX4GTA	5	7247	1
17AY3A/17BS3A	23	7355	2
17BE3	13	7408	1
17BF11	15	7591A	13
17C9	2	7868	9
		8417	3

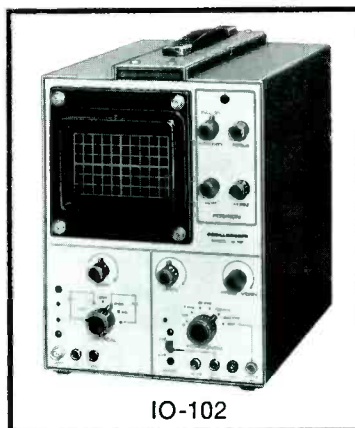

IO-102

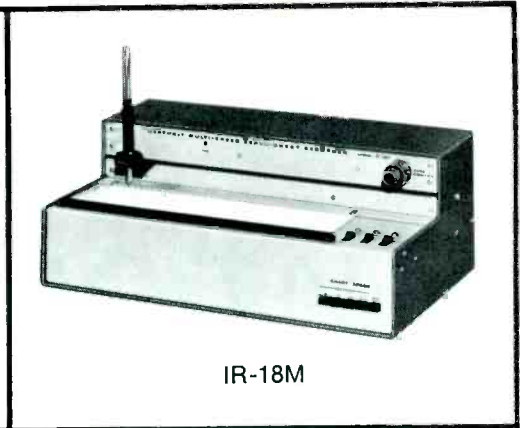

IR-18M

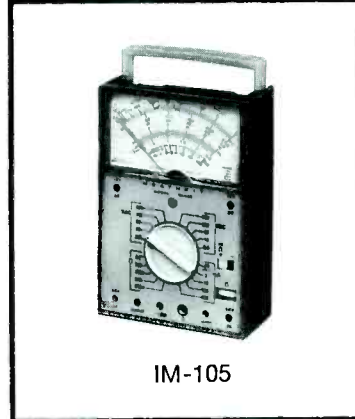

IM-105



IB-101



IB-102

New Heathkit® Cost-Cutters

Here's happy news for budget-watchers... a complete new line of Heathkit solid-state test instruments designed to deliver professional performance at traditional Heathkit savings:

NEW Heathkit IO-102 5" solid-state scope delivers DC-5 MHz response... AC or DC coupling... Hi-Z FET input... 30 mV/cm sensitivity... continuous sweep rates from 10 Hz to 500 kHz... external horizontal & sync inputs... 1 V P-P output... large flat face CRT with 6x10 cm ruled graticule... choice of kit or assembled. **Kit IO-102**, 29 lbs., **119.95***. **Assembled IOW-102**, 29 lbs., **179.95***

NEW Heathkit IM-105 VOM... 8 DC ranges to 5 kV; 7 AC ranges to 5 kV; 6 DC current ranges to 10 A; 5 ohms ranges to x10 k with center scale of 20; 5 dB ranges to +50. High impact Lexan® case & ruggedized taut-band protected meter. Exceptional accuracy. Easy assembly. **Kit IM-105**, 4 lbs., **47.95***

NEW Heathkit IR-18M solid-state chart recorder... 12 pushbutton selected speeds... 1 mV or 10 mV full scale... full 10" chart width... 1 second full scale pen response... 3-terminal floating input... 240 Hz photo-chopper reduces 60 Hz noise. Fast, easy assembly, rapid paper loading. **Kit IR-18M**, 14 lbs., **149.95***

NEW Heathkit IB-101 solid-state frequency counter... 1 Hz to over 15 MHz range... 5 digit cold-cathode tube readout... overrange indicator & Hz/kHz switch for 8-digit capability... wide range input without adjustment... low triggering level... 1 megohm input... rock-stable time base. **Kit IB-101**, 7 lbs., **199.95***

NEW Heathkit IB-102 solid-state frequency scaler... turns virtually any counter into a 175 MHz counter. Scales 100:1, 10:1 or 1:1. Very low triggering level. Easy assembly & operation. Compatible with practically all 1 megohm input counters. **Kit IB-102**, 7 lbs., **99.95***

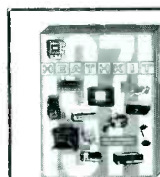

FREE '71 CATALOG

Describes these and over 300 other Heathkits. Save up to 50% by building them yourself. Use coupon and send for your FREE copy!



HEATH COMPANY, Dept. 25-6
Benton Harbor, Michigan 49022 a Schlumberger company

- Please send FREE Heathkit catalog
- Enclosed is \$ _____, plus shipping.
- Please send model(s) _____

Name _____
Address _____
City _____ State _____ Zip _____

Prices & specifications subject to change without notice.
*Mail order prices; FOB factory. TE-244

Circle 26 on literature card

NATIONAL ELECTRONIC ANNUAL CONVENTION

Both Business and Recreation Activities Included

Business highlights

Topping the list of business-oriented activities is a two-day Business Management School, conducted jointly by faculty members of Portland Community College and service industry leaders, including John Sperry (Sperry TV, Lincoln, Nebraska) and Jim Rolison (Electromatic, Portland, Oregon). Topics which will be presented include an "Introduction to Business Management", by Dr. Amo DeBernardis, Portland Community College; "Shop Layout", by John Sperry; "The Law and the Service Company", by Roger Meyer; "Practical Financial Management", by John Sperry; and "The Why's and Wherefore's of Service Contracts", by Jerry Canter. The School begins at 9:00 AM on Thursday (July 15) and ends at 4:30 PM on Friday (July 16).

A series of "association-management" oriented seminars also are included in the business agenda. These sessions reportedly are presented to acquaint state and local association members with proven techniques for developing and managing their own associations. Individual sessions will discuss membership recruitment, association conventions, publication of association newsletters, improved board meetings, state and local association financing, and planning and executing educational programs. These seminars are scheduled for Friday (July 16).

Recreation highlights

Deep-Sea fishing, a bowling tournament and an "NEA Open" golf tourney head up the family and group recreational activities planned for the convention.

Other activities include an Indian Bar-B-Que and sight-seeing tours of nearby geographical and historical attractions.

Most of the group recreational activities have been scheduled Monday through, and including, Wednesday (July 12-14), with the exception of the golf and bowling tournaments, both of which are scheduled for Thursday morning (July 15).

Information about these recreational activities—including dates, times and costs—will be sent to all individuals who pre-register for the convention.

Business Agenda

Wednesday, July 14

8:00 PM—Meeting of state association presidents (**Room 246/48**)

Thursday, July 15

9:00 AM—Convention opening address, by Dr. Amo DeBernardis, Portland Community College (**No location given**)

9:00 AM to 4:30 PM—Business Management School (**Washington Room**)

12:00 Noon—Business Management School luncheon (**Portland Community College**)

3:00 PM—Budget and Finance, Hall of Fame and Executive Committees Meetings (**Room 250**)

8:00 PM—NEA Board of Directors meeting (**Room 246/48**)

Friday, July 16

9:00 AM to 4:30 PM—Business Management School (**California Room**)

9:00 AM to 10:00 AM—Association Seminars: Membership Recruitment (**Room 244**)

ASSOCIATIONS' AGENDA

The seventh annual convention of the National Electronic Associations (NEA) will be held July 12-18 at the Portland Sheraton Hotel, Portland, Oregon.

Convention Organizing (**Room 242**)
Association Newsletters (**Room 240**)

10:30 AM to 11:30 AM—Association Seminars:
Better Board Meetings (**Room 240**)
Financing State and Local Associations (**Room 244**)
Planning Educational Meetings (**Room 242**)

11:45 AM—Luncheon, included in "package price" of convention (**East Ballroom**)

1:00 PM to 2:00 PM—Repeat of association seminars conducted 9:00 AM to 10:00 AM (**Same rooms**)

2:30 PM to 3:30 PM—Repeat of association seminars conducted 10:30 AM to 11:30 AM (**Same rooms**)

4:00 PM—Convention Keynote Address, NEA President Norris Browne, CET (**West Ballroom**)

6:00 PM—Hall of Fame Banquet, included in "package price" of convention (**East Ballroom**)

Saturday, July 17

9:00 AM—Annual membership meeting of NEA, general session (**West Ballroom**)

11:45 AM—Luncheon, included in "package price" of convention (**East Ballroom**).

1:00 PM—Annual membership meeting (continued), general session (**East Room**)

5:30 PM—Cocktail party sponsored by Howard W. Sams & Co., Inc. (publishers of ELECTRONIC SERVICING magazine), included in "package price" of convention (**Ballroom**)

6:30 PM—NEA President's Banquet and Dance, included in "package price" of convention (**Ballroom**)

Sunday, July 18

10:00 AM—Annual membership meeting (continued from Saturday), general session (**Oregon/Washington Room**)

10:00 AM—International Society of Certified Electronic Technicians Board of Delegates meeting (**Room 246/48**)

(Sunday, July 18 continued)

2:00 PM—New NEA Board of Directors meeting (**Room 246/48**)

Convention Registration Fees

The registration fee per person for the complete convention—including two luncheons, the NEA President's Banquet, the Hall of Fame Banquet, and Howard W. Sams Cocktail Party—is \$35.00 (does not include cost of family and group recreational activities.)

Cost of the two-day Business Management School is \$30.00, including two luncheons.

Individuals who do not wish to attend the complete convention, but do want to attend select sessions, can do so by paying a per-session fee.

Registration forms and additional information can be obtained by writing:

NEA, Inc.
1309 W. Market Street
Indianapolis, Indiana 46222

Hotel Reservations

Individuals planning to attend the convention must make their own hotel reservations direct with:

Portland Sheraton Hotel
1000 N. Multnomah Street
Portland, Oregon.



How Circuit Defects Affect Video Waveforms

Because the video detector is the "half way" point between the antenna and the picture tube, the waveform there is useful for localizing the cause of video-related troubles.

An oscilloscope equipped with a demodulation probe will display a blurred, narrow-bandwidth waveform of the video modulation (Fig. 1A) present in the video IF's. This technique is valuable principally for signal tracing, because the information it provides about the quality or quantity of the video signal is very limited. This is because connection of a demodulator probe to a resonant circuit seriously detunes the circuit, lowering the "Q" and resonant frequency, which often makes the results unpredictable, particularly in a stagger-tuned circuit.

Characteristics Of A Normal Video Detector Waveform

A wide-band scope connected to the output of the video detector via a low-capacitance probe (a direct probe "blurs" the waveform) will display a waveform that reveals the approximate bandwidth of the tuner and IF stages. This waveform also

will reveal hum, sync clipping, and other defects.

A typical, normal video detector waveform is shown in Fig. 1B (scope horizontal sweep operated at 7867 Hz, to produce two blanking/sync pulses). The same waveform produced after the sweep width of the scope has been widened by use of the X5 switch is shown in Fig. 1C. Overshoot on the right side of the horizontal sync pulse is clearly visible, and the nine cycles of color burst can be counted easily.

Scanning the same video detector output at a sweep rate of 30 Hz produces the waveform shown in Fig. 1D. However, widening the scope display with the X5 switch makes the equalizing pulses and vertical sync pulses visible (Fig. 1E).

Because some defects can be seen more readily at one scanning frequency than at the other, waveforms should be examined at both 7867 Hz and 30 Hz.

Previous stages, including the tuner and video IF's, probably have normal bandwidth if the waveforms are identical, or nearly identical, to the following examples.

Fig. 1 Normal video waveforms. (A) Video waveform (7867 Hz) obtained in the video IF's by use of a demodulator probe. Some demodulator probes employ more internal filtering and cause even more blurring. Waveforms produced by such probes should be scanned at 30 Hz. (B) Video waveform at the output of the video detector (7867 Hz). (C) Video waveform at the output of the video detector scanned at 7867 Hz and expanded by the X5 magnification function of the scope. (D) Video at the output of the video detector (30 Hz). (E) Video at the output of the video detector scanned at 30 Hz and expanded five times normal width.

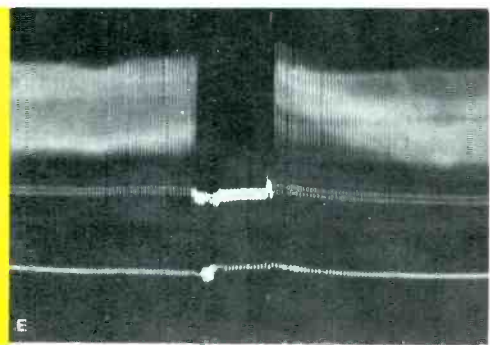
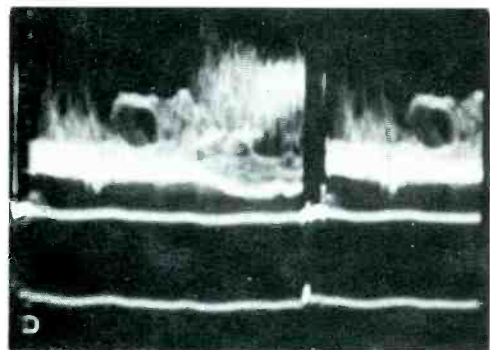
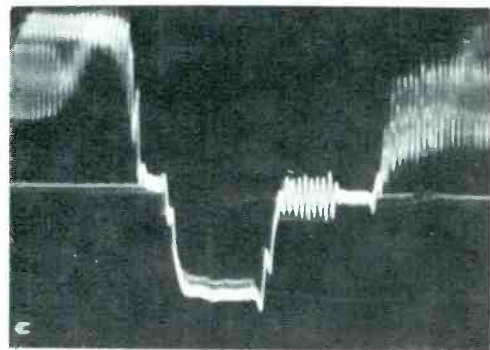
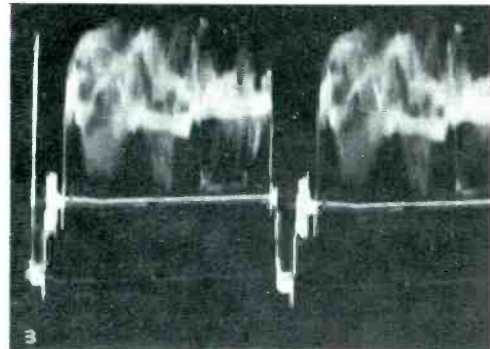
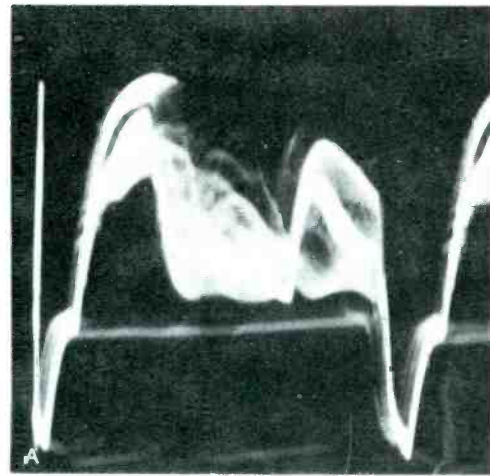

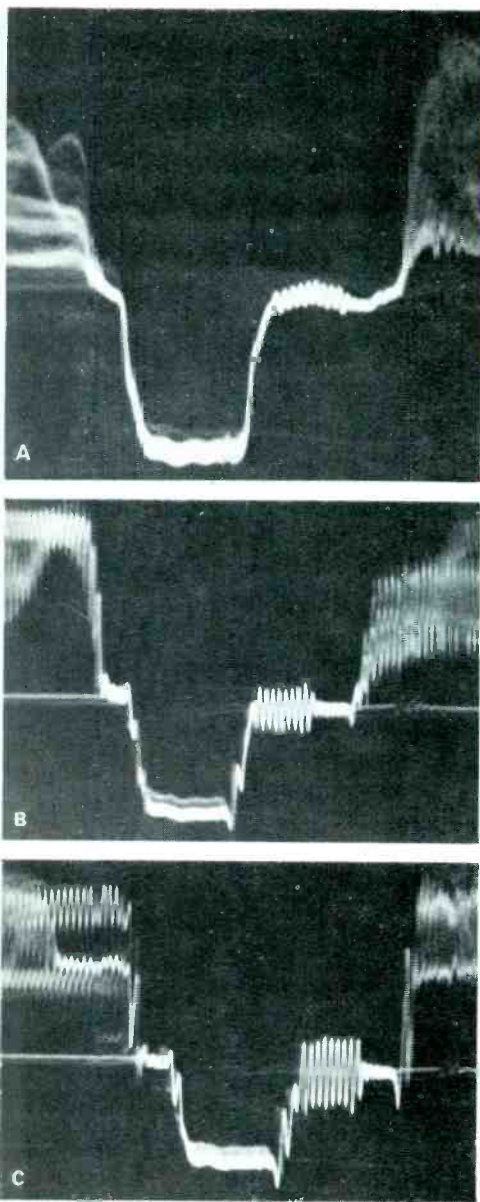

Fig. 2 Composite waveform at the video detector at various settings of the fine tuning (7867 Hz, X5). (A) Fine tuning adjusted away from the sound bars. Frequency response is -6 dB at approximately 3 MHz. (B) Normal fine tuning near the sound bars. Frequency response is -6 dB at approximately 3.6 MHz. (C) Fine tuning adjusted slightly into the sound bars; some 920-KHz beat pattern is evident on the screen. Frequency response is -6 dB at approximately 3.8 MHz.

burst signal is eight cycles or more of a 3.58-MHz sine wave on the "back porch" of the horizontal blanking pulse (Fig. 1C), the amplitude changes according to the video response at 3.58 MHz. Therefore, the amplitude of the burst signal at the output of the video detector (where the bandwidth is the widest) can be used as an indication of the video IF bandwidth. Examine the amplitude of burst while you tune in several stations and correctly adjust the fine tuning each time. From the average of these amplitudes, evaluate the approximate bandwidth, remembering that the greater the amplitude of burst, the wider the effective bandwidth.

Normal Changes In The Video Amplifier Waveforms

Some changes in the video wave-

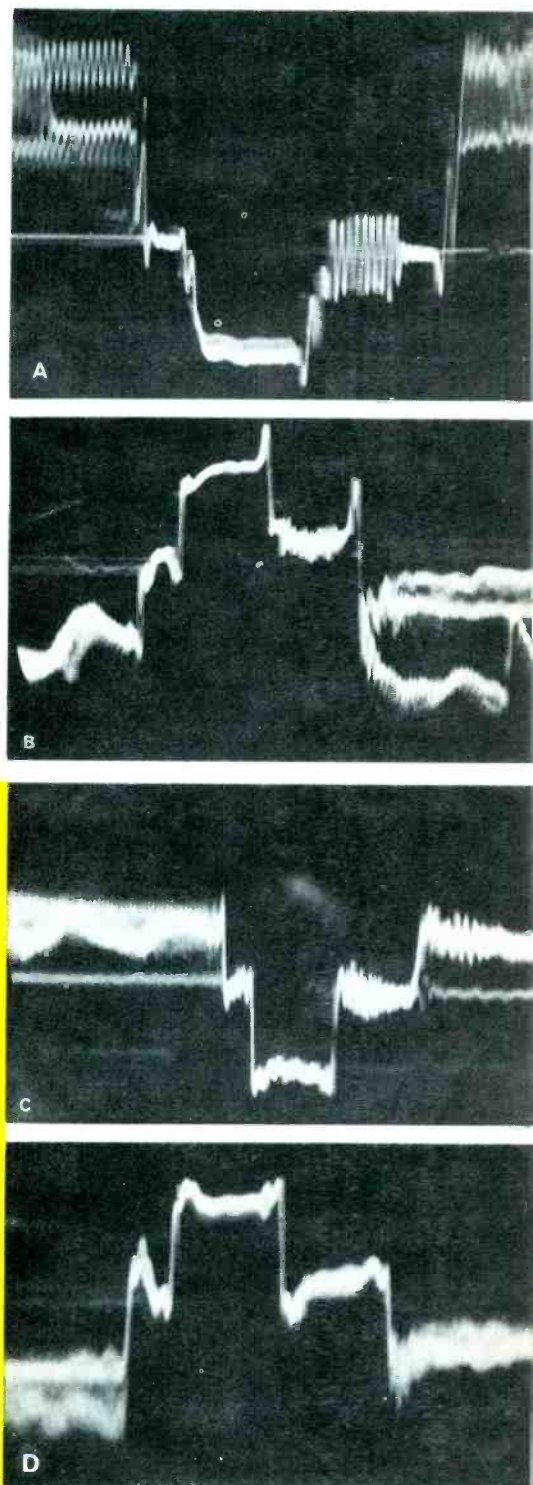

Fig. 3 Waveforms showing normal changes of bandwidth as video is processed through the three video amplifier stages of the RCA CTC15 chassis. All are scanned at 7867 Hz and X5 width. (A) Waveform at the output of the video detector. (B) Waveform at the plate of the 1st video amplifier tube. (C) Waveform at the grid of the 12BY7 video output tube. (D) Waveform at the plate of the video output tube. The horizontal sync pulse normally is compressed at the higher settings of the contrast control.

Narrow Bandwidth Causes Video Waveform Changes

When the fine-tuning control is varied, changes in the frequency of the tuner oscillator cause corresponding changes in the effective bandwidth of the signal in the video IF's (see page 33, September, 1969 *ELECTRONIC SERVICING*). Such changes usually are evident in the waveform at the output of the video detector, as shown in Fig. 2.

The sharpness of the corners of the sync pulse varies with changes in bandwidth. Even more noticeable is the change in the amplitude of the color burst. As pointed out last month, only the **amplitude** changes when a sine wave travels through frequency-selective circuits. Consequently, because the color

Fig. 4 Comparison of one vertical bar of a crosshatch pattern on the screen of a color picture tube (bottom) and the waveform that produced it. Overshoot in the peaking circuits causes the black line on the right of the white vertical crosshatch bar.

It might be of interest to you to know how this waveform was obtained, because one distinctive feature of a triggered-sweep scope was used. A color-bar generator, with the crosshatch pattern selected, was connected to the antenna terminals of the color receiver, and the normal receiver adjustments made. Video for the scope was taken from the top of the video drive controls. An external sync pulse was obtained by using a test lead positioned near the yoke leads. The SWEEP-TIME/CM (frequency) control on the triggered sweep scope was set for 1 μ s, then the trigger level and stability knobs were experimentally adjusted so that just one of the pulses which form the vertical lines of the crosshatch could be seen on the scope screen. Photographs were made of the scope screen and the screen of the picture tube.

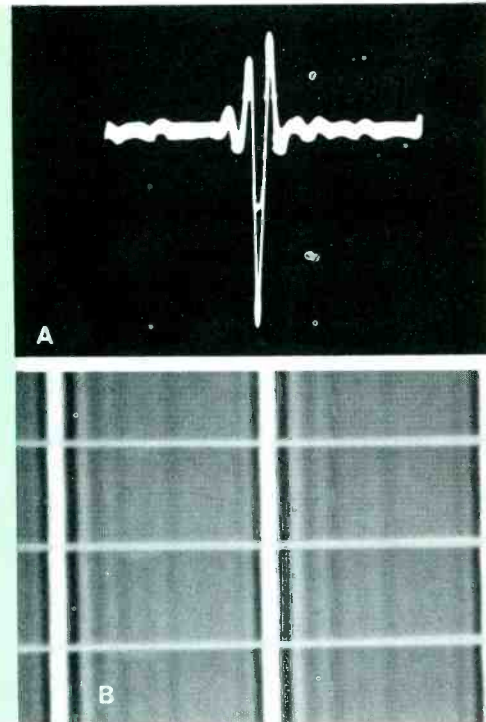

form are normal as it progresses through the video amplifier stages of a color TV receiver, and should be expected.

The waveforms shown in Fig. 3 were produced by an RCA CTC15 color chassis, and are typical of those produced by most other color receivers.

The video detector waveform is shown in Fig. 3A.

The waveform at the plate of the first video amplifier is shown in Fig. 3B; the right sides of the blanking and sync pulses indicate overpeaking, and there is a reduction in the amplitude of the burst signal.

(Because this plate is the take-off point for the chroma signal, loading by the first tuned circuit in the chroma channel reduces the amount of burst.)

Fig. 3C is the waveform at the grid of the 12BY7 video output tube. Fig. 3D shows the waveform at the plate of the same tube (which drives the three cathodes of the picture tube). At high settings of the contrast control, most of the horizontal sync pulse is clipped off; this is of no consequence because the sync separator signal is taken from the plate of the 1st video amplifier.

How Peaking Circuits Affect The Waveforms

The antenna-to-video detector frequency response of a good color receiver should be down only 6 dB (50 percent reduction of voltage) at 3.58 MHz. However, to eliminate beat patterns, the chroma sidebands must be filtered out in the circuitry between the output of the video amplifier and the picture tube. This is usually accomplished by peaking circuits designed to filter out the frequencies above 2.5 MHz, in addition to their main task of boost-

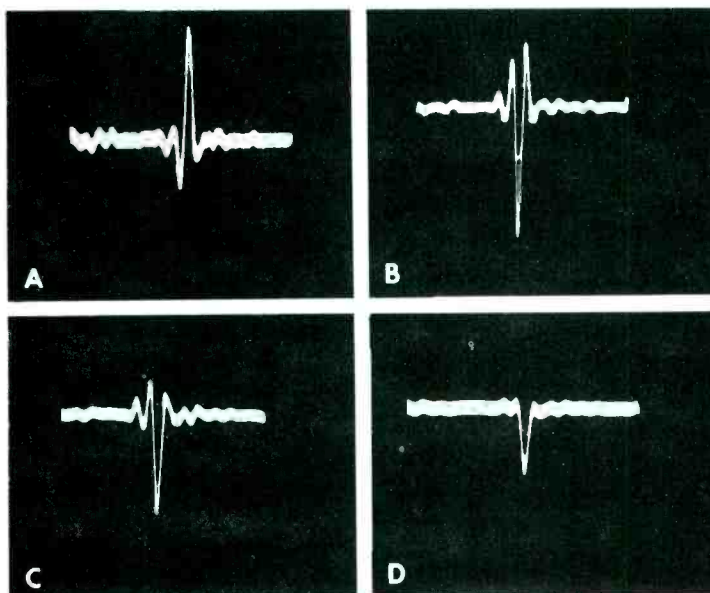

Fig. 5 Scope waveforms of one crosshatch vertical bar under various conditions. All waveforms were scanned at 7867 Hz and X5. (A) Normal waveform at the output of the video detector. The positive "pre-shoot" pulse on the left of the white, or negative, pulse evidently is produced by the color generator. (B) Normal waveform at the plate of the 12BY7 video output tube; the peaking switch is set for maximum, and the contrast control is set at about the 50-percent point so that the high-frequency boost in the cathode circuit of the 12BY7 will be effective. The amplitude of the positive "overshoot" pulse which produces the black line on the right of the white vertical crosshatch bar is maximum. (C) Waveform indicates slightly less bandwidth; positive pulse which produces the black line on the right of the vertical crosshatch bar has less amplitude. Reduced bandwidth was the result of peaking switch at "minimum-bandwidth" position, or an open peaking coil in the grid circuit of the 2nd video amplifier. (D) Dim and blurred white bar without the enhancing overshoot pulses on either side is the result of adjusting the fine tuning too far from the sound bars.

ing those frequencies just below the cut-off point.

The boost (by the peaking circuits) of the frequencies between approximately 2 MHz and 2.5 MHz causes a small amount of overshoot, which adds an outline around the right side of any fine detail in the picture, enhancing the illusion of sharpness, as shown in Fig. 4.

Excessive peaking causes ringing, which resembles evenly spaced ghosts.

Changes which occur to the pulse shown in Fig. 4 as the pulse travels through the video stages are shown in Fig. 5. The effect of an open peaking coil or a peaking switch adjusted to produce minimum bandwidth is shown in Fig. 5C. The small-amplitude pulse shown in Fig. 5D was produced by deliberately misadjusting the fine tuning to produce a blurred picture. Notice the absence of the "black-level" pulses on both sides of the "white-level", or negative, pulse; the black-level pulses, normally present, produce the black outline on both sides of the crosshatch vertical white lines, as explained in Fig. 4.

Crosshatch patterns displayed on the screen of the picture tube can be analyzed also. Each generator and each model of color receiver will present a slightly different crosshatch pattern, but it requires little time for a technician to learn what to expect. Some examples are shown in Fig. 6.

Blanking Signals Change The Video Waveform

Vertical and/or horizontal blanking pulses are often combined with the video signal at some point in the video amplifier circuit. These additions change the appearance of the video waveforms. Fig. 7A shows the video waveform, without the vertical blanking pulse, at the plate of the 12BY7 video output tube in the RCA CTC15 chassis. Fig. 7B is the same video waveform with the normal vertical blanking pulse added.

Snow and Noise Change The Video Waveform

Snow and noise cause blurring of the video waveform, as shown in Fig. 8. In addition, the AGC voltage changes which accompany weak signal reception often tilt the video IF alignment curve, producing a noticeable loss of sharpness.

Hum Changes The Video Waveform

Hum is probably the most frequent cause of video waveform distortion. In addition to the blacked-out horizontal bars, which can be seen on the screen of the picture tube, hum also can cause horizontal and vertical sync problems.

Heater-to-cathode leakage in tubes is the most likely cause of hum, although defects in power supply filtering, poor grounds which are common to the signal and AC currents, leakages across circuit boards, and other defects can cause hum in the video signal, even in solid-state circuits.

To check for hum, always set the scope sweep for 30 Hz. Fig. 9A shows a typical, normal video waveform at the output of the video detector. Fig. 9B is the same, except that hum in the AGC voltage has added a huge amount of hum modulation. Hum moves across the video waveform; this characteristic helps to distinguish it from similar disturbances.

The frequency of the hum in Fig. 9B is 60 Hz, as indicated by the appearance of **one** hum sine wave for each video waveform. **Two** sine waves (or sawteeth) between blanking pulses indicate a hum (or ripple) of 120 Hz, which only can originate in a frequency doubling type of power supply. Remember, however, not all voltage doubling power supplies also double the frequency.

When the hum moves until the vertical sync is at the tip of the hum (see Fig. 9C), vertical roll from lack of sync will often occur. This accounts for many cases where the rolling occurs on a regularly

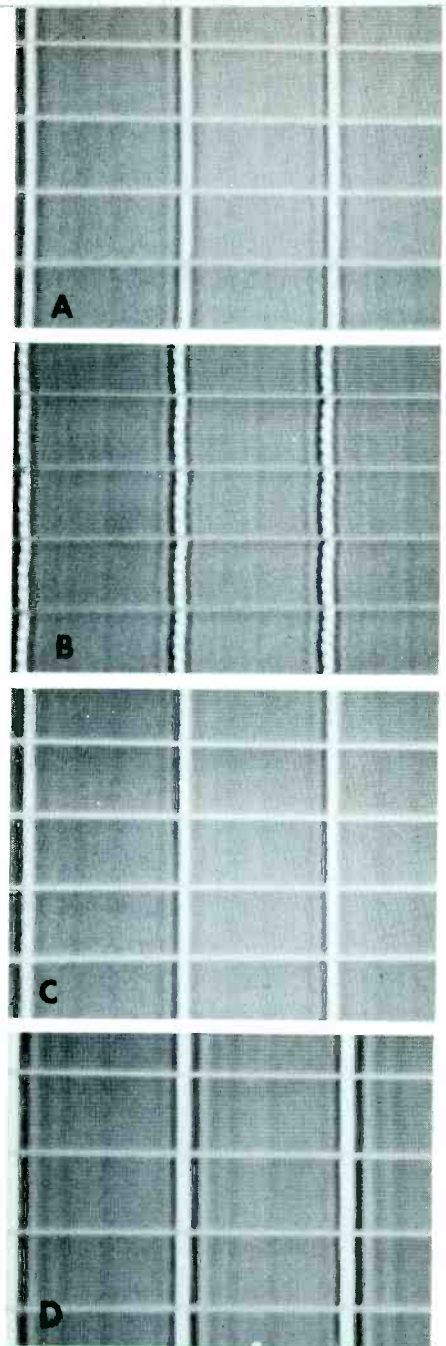

Fig. 6 Crosshatch patterns displayed on the screen of the color picture tube. (A) Normal conditions, with gray-black line evident on the right of the white vertical bar. (B) Fine tuning adjusted slightly into the sound bars (4.5-MHz sound carrier of generator turned on). Because the sound carrier is unmodulated, mistuning produces "beads" around the white vertical bar. (C) Blurred white vertical bar with no black line on the right, because the fine tuning was adjusted to a setting too far from the sound bars. (D) Slight amount of ringing following the white bar might be caused by too large a value of C32 or an open damping resistor connected in parallel to a peaking coil.

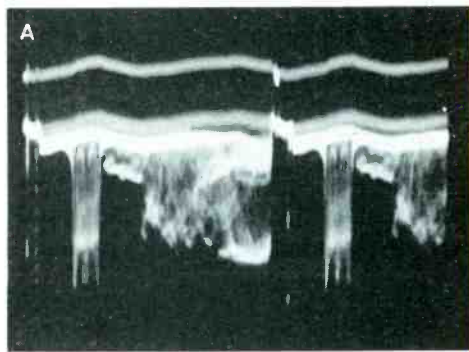

Fig. 7 Application of blanking pulses to a video stage change the waveform. (A) Waveform at the plate of the 12BY7, with the vertical blanking pulse missing (30 Hz, X1). (B) Normal waveform at the plate of the 12BY7, with the vertical blanking pulse present (30 Hz, X1).

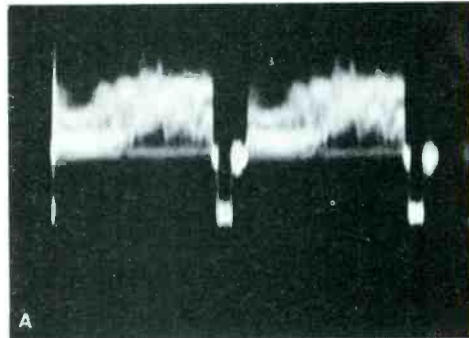
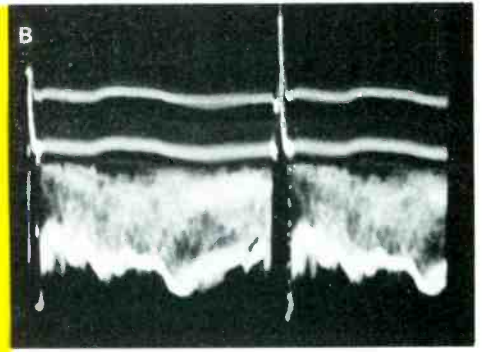

Fig. 8 Snow and noise also change the waveform. (A) Video detector waveform exhibiting the effects of light snow (7867 Hz, X1). (B) Same waveform with heavy snow (7867 Hz, X1).

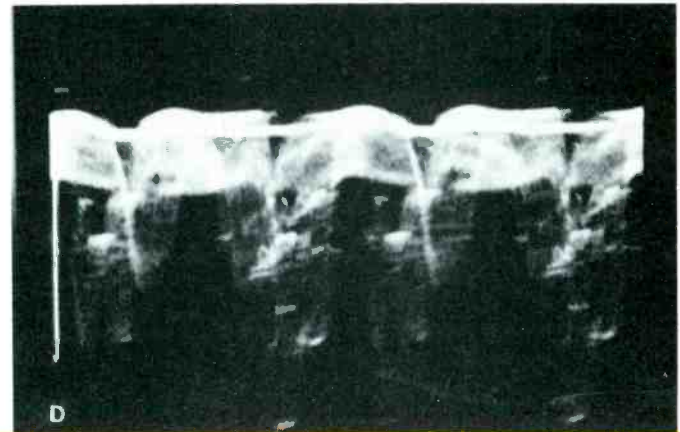
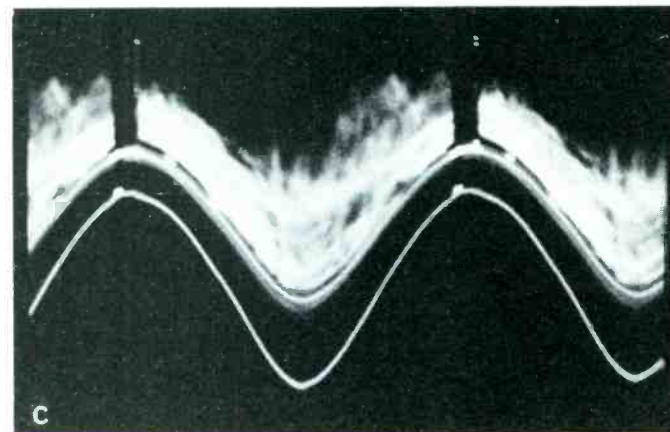
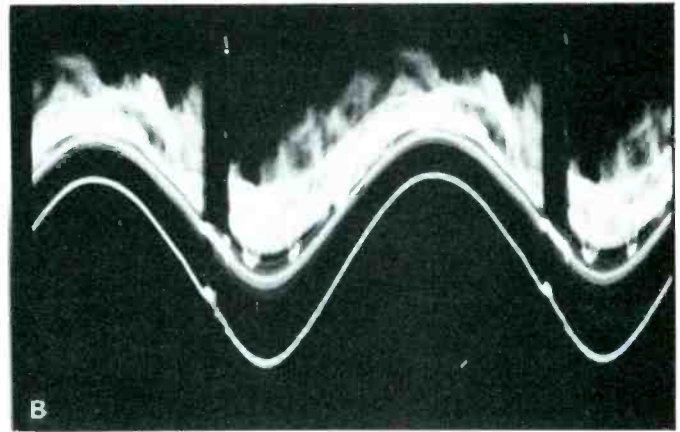
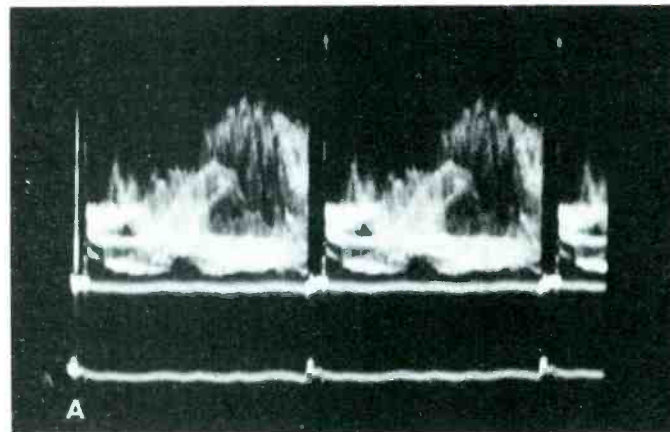
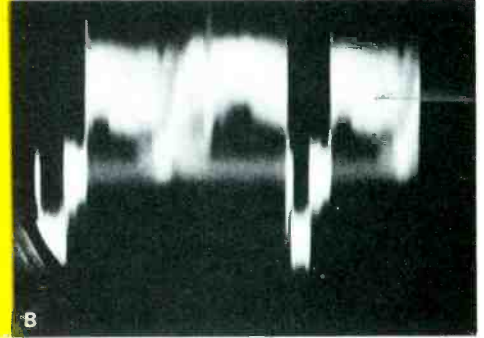

Fig. 9 Hum Modulation of the video waveform is common. (A) Normal waveform produced at the output of the video detector (30 Hz, X1). (B) Same waveform showing excessive amount of 60-Hz sine-wave hum. (In this case, vertical sync was unaffected because the sync interval occurred during less-positive portion of hum waveform.) (C) Same conditions as (B), except the hum has moved until it is interfering with sync separation during the vertical sync interval. (The picture rolled vertically during this time.) (D) When hum is severe, the waveform often cannot be locked properly at 7867 Hz, as shown here.

recurring basis.

When a large amount of hum is mixed with the video, any attempt to lock the scope at 7867 Hz probably will produce only a "jumble" such as that shown in Fig. 9D.

Non-linearity Changes The Video Waveform

Non-linearity in video amplifier stages causes "clipping" or "compression" of the waveform. Seldom will the waveform be stretched; or if it is, the stretching will not be noticeable. Clipping or compression of either the top or the bottom of the waveform can occur. Overload of a video IF or a video amplifier stage usually will compress the horizontal sync side of the waveform. For this reason, it is often called "sync clipping", even though the black-level of the video and part of the horizontal blanking also might be compressed. Fig. 10B shows such sync clipping, which, in this case, was caused by overload of a video amplifier following an AGC defect. This type of clipping must be avoided in all stages prior to the point where signal for the sync separator is obtained. Poor vertical and horizontal sync or horizontal pulling are the usual results of sync clipping.

Fig. 10C shows "white compression" which is more noticeable in pictures on the screen of the picture tube than is sync clipping. All of the video from white to medium gray is compressed to the same amplitude. White compression does not

occur often but it can be produced when the following conditions are present in color receivers which use a 12BY7 video amplifier tube:

- A peaking coil in the plate circuit of the 12BY7 opens and the resistor in parallel with the coil functions as a large-value plate-load resistor.
- The brightness control is adjusted to produce high brightness, and, as a result, the 12BY7 draws a large amount of plate current, and the plate voltage decreases to a very low level (lower than the screen voltage).

White compression can be seen easily if the brightness control is varied, because the amount of compression changes. The screen symptom is similar to that produced by some weak b-w picture tubes.

Summary

Analyzing video detector and video amplifier waveforms can help a technician quickly locate the source of many defects.

However, before a technician can analyze properly these waveforms, he should understand how limited frequency response affects pulses and square waves, and also should know which waveform changes produced by peaking circuits and blanking signals are normal. Also, he should understand how hum and non-linearity affect waveforms.

Effort must be expended to acquire this knowledge, but it is worth it—and more—because of the time saved during troubleshooting. ▲

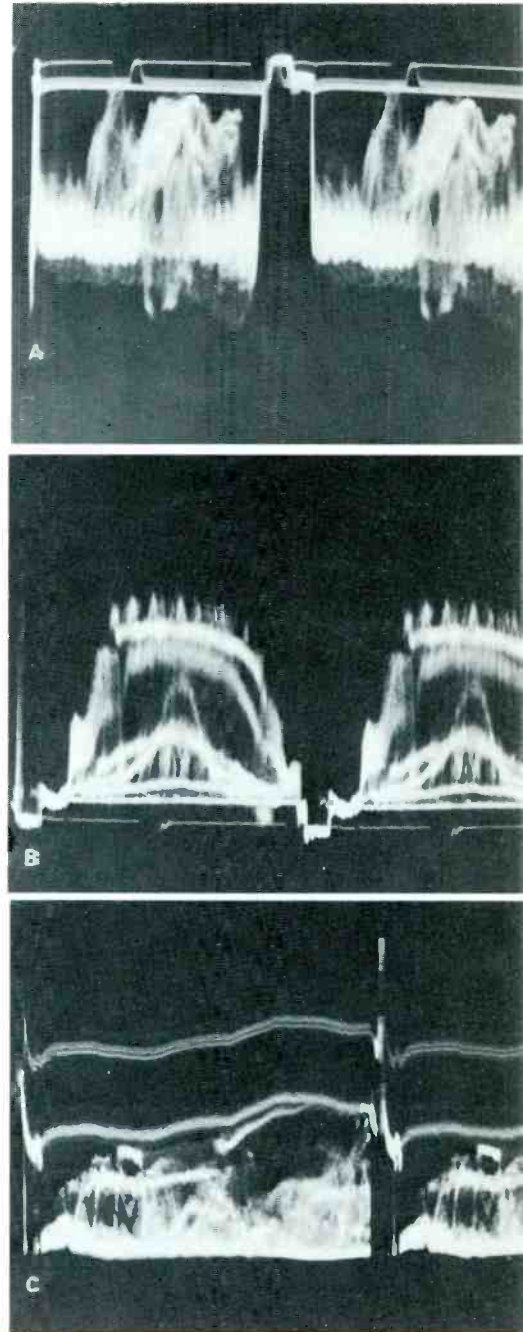

Fig. 10 Non-linearity causes sync (black level) clipping, or white compression. (A) Excessive signal at the video detector output (produced by an AGC defect) causes compression of the horizontal sync at the plate of the 1st video amplifier. Black level (sync) compression usually is caused by overload resulting from excessive signal amplitude (7867 Hz, X1). (B) Similar sync clipping also is present at the grid of the video output tube (7867 Hz, X1). (C) Waveform exhibiting white compression (30 Hz, X1) can be caused by insufficient bias on an amplifier stage, which, in turn, causes a lower plate than screen voltage.

antenna systems report

CTC Log Periodic

JFD announces the new LPV-CTC log periodic VHF/UHF/FM antenna featuring Color Tuner Capacitor-coupled (CTC) VHF elements.

The JFD antenna reportedly also features new wide-aperture tapered disc directors. A new "wedge-shaped" trapezoid driver works in tandem with the disc directors to increase the UHF sensitivity and selectivity, according to the manufacturer.

The CTC VHF dipole design works on both the fundamental and harmonic modes, which, according to the manufacturer, provides higher gain and higher front-to-back ratio than other same-sized antennas, and improved signal transfer from antenna to transmission line across all bands.

The CTC utilizes colorful insula-

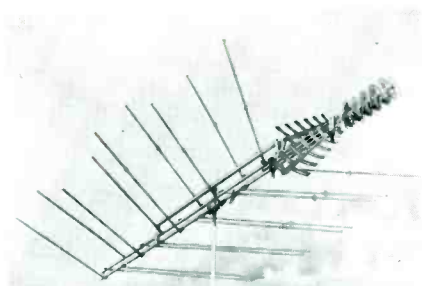

tors and capacitors, plus gold colored alodized aluminum construction and twin square crossarms.

The LPV-CTC line reportedly is comprised of eight antennas to cover reception locations from local to far fringe.

Prices range from \$21.70 to \$85.50.

Circle 70 on literature card

All-Channel TV Splitters

An all-channel signal splitter, Model 1572G, which connects two TV receivers to one Ultra-tap, is now offered by Jerrold Electronics Corp.

The Ultra-splitter plugs into a

Jerrold outlet and converts it from a single outlet to a dual outlet. The hybrid unit reportedly prevents interaction between receivers, mates with gamma fittings and is used for all-channel color TV, reports the manufacturer.

Splitting loss is 3.5 dB from 54 to 216 MHz and 3.8 dB from 470 to 890 MHz, according to the manufacturer; isolation between outputs reportedly is a nominal 15 dB.

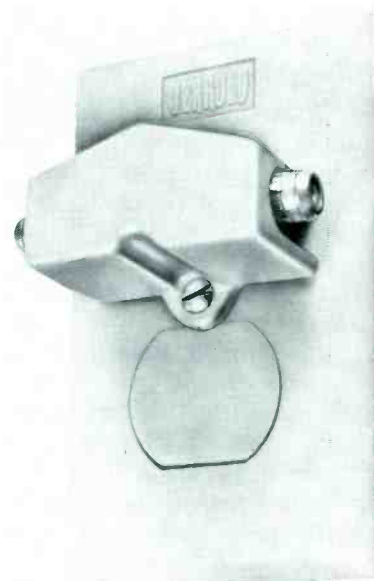

Price of Model 1572G is \$9.25.

Circle 71 on literature card

FM Attenuator

A new FM attenuator trap which attenuates the FM band by 20 dB and is reportedly designed for use in broadband MATV systems has been announced by the JFD Electronics Corp.



To eliminate cross modulation in Channels 2 to 6 in the low VHF

Quick-Servicing Info About COLOR TV, B-W TV, and STEREO



COLOR TV . . . Now in one easy-reference book, all of the practical color TV troubleshooting information published in TV TECH AID in 1970 . . . A valuable, single source which lists the symptoms, probable causes and proven cures of over 400 recurring troubles in major-brand color TV, plus tried-and-proven troubleshooting tips . . . Indexed by brand and chassis or model number for fast reference . . . **ONLY 5.95**



BLACK-AND-WHITE TV and stereo . . . By popular request, the publishers of TV TECH AID have compiled in one book over 400 symptoms, causes and cures of troubles that have recurred in leading brands of b-w TV and stereo . . . Indexed by brand and chassis or model number, for quick reference . . . **ONLY 5.95**

TV TECH AID

answers technicians' requests . . . the causes and cures of recurring troubles in major-brands of color and b-w TV are now available in separate books . . . each of which provides exclusive coverage of either color or b-w TV (Stereo coverage is included in the B-W Volume)

ORDER NOW!

TV TECH AID

P.O. Box 603
Kings Park, N.Y. 11754

ENCLOSED IS A CHECK OR
MONEY ORDER FOR \$.....

PLEASE SEND: 1969-12 BACK ISSUES \$4.95

B-W TV BOOK (\$5.95) COLOR TV BOOK \$5.95)

1971 TV TECH AID-12 ISSUES-\$7.95

TO: Name

Address

City

State

Zip.....

Circle 27 on literature card

band and second harmonic beats in Channels 7 to 13 in the high VHF band, FM signals reportedly are attenuated by the Model 8488 before they are fed from the antenna to the head end amplifier.

The 8488 has a reported attenuation of less than 1.5 dB at 88 MHz, and a VSWR of 1.2 to 1.

Model 8488 is compact, and sells for \$12.50.

Circle 72 on literature card

Mobile Communications

Antenna

This new high-impact, low-profile mobile antenna design is announced by The Antenna Specialists Company.

Known as the "Linebacker", the new antennas reportedly are designed to provide optimum electrical performance while virtually impervious to forced removal or normal breakage from impact with car wash equipment, tree limbs, etc.

The Linebacker antennas evolved from Antenna Specialists' latest aircraft antenna designs, according to the manufacturer. They are built for maximum electrical and mechanical rigidity and are unaffected

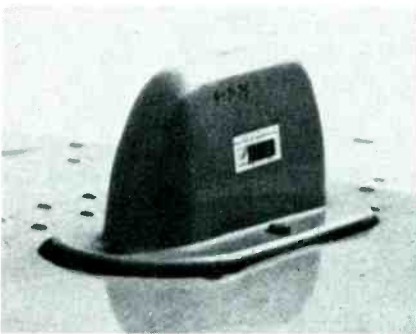

by environmental conditions. The molded high-impact design is less than 4½ inches high in the 138-174 MHz VHF models, and less than 3½ inches high in the 450-470 MHz UHF models. Both models are field tuneable to VSWRs of 1.5:1 or better. When mounted on a horizontal surface, such as a car roof, they reportedly radiate an efficient omni-directional pattern which is vertically polarized for compatibility and maximum performance in existing communications networks.

Prices of the five available models range from \$19.25 to \$32.95.

Circle 73 on literature card

Antenna Multicoupler



Designed to connect eight receivers to a single antenna with adequate isolation and minimum interaction among receivers, American

Electronic Lab's Model AMC 2359 multicoupler unit covers the frequency spectrum from 30 MHz to 300 MHz and can be mounted in a standard 19-inch rack according to the manufacturer.

Price is available from the manufacturer upon application. ▲

Circle 74 on literature card

**For more information
about above products
use reader service card**



**B&K
Precision
Model 1460
Triggered
Sweep Scope
\$389.95**

B & K Precision's new 1460 Triggered Sweep Scope... The one that's been worth waiting for.

You won't believe how easy it is to sync TV-V and TV-H signals until you've actually tried it.

Trouble shooting complex TV circuits takes enough time without having to fiddle with dials and controls to adjust to the proper wave form.

That's why the new B&K Triggered Sweep Scope features the TV-H and TV-V positions. These are the two new positions you've always needed for quick one-knob selection of horizontal or vertical TV signals. Exclusive sync separator circuit. No complicated and time-consuming adjustments . . . just flick a single knob.

Fully automatic triggered sweep lets you view the entire complex TV signal or any part of it. Including the VITS (vertical interval test signal).

And the "back porch" of the horizontal sync pulse, with color burst information. All locked in rock steady.

All solid state with 6 FETS. Runs coolest. Vertical sensitivity (10mV/cm) and writing speed of 0.1 microsecond/cm (using 5X multiplier). Features usually found in expensive lab scopes. Complete with direct/10 to 1 probe. 19 sweep speeds and 11 voltage calibrated ranges, DC to 10 MHz.

Pinpoint your problems quickly and accurately with the new 1460 Triggered Sweep Scope. The only thing you'll have to adjust to is having more time on your hands. Ask your distributor or write for our free catalog.

There is a difference in test equipment—ours works!



Product of DYNASCAN CORPORATION
1801 W. Belle Plaine / Chicago, Illinois 60613

Circle 28 on literature card

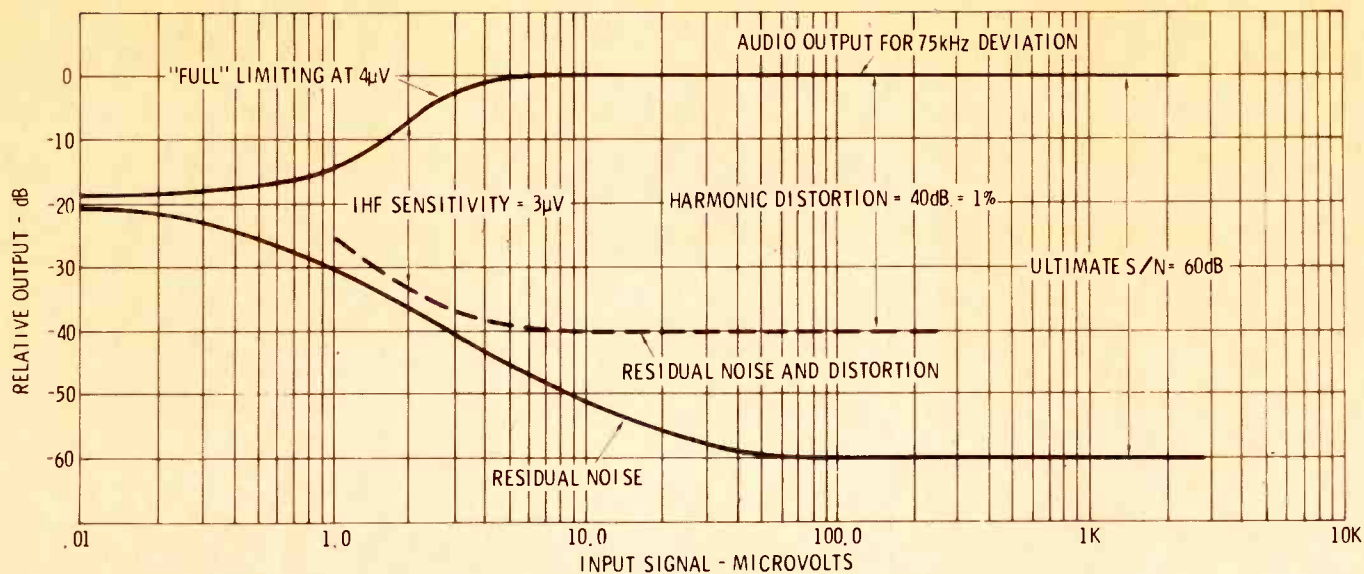

Fig. 1 Quieting and limiting characteristics of a typical FM tuner.

Stereo FM Tuner Performance Evaluation and Adjustments

by Leonard Feldman

Checking out a stereo FM tuner is a more demanding job, technically, than checking out or aligning the most complex AM radio or AM tuner. The circuitry in stereo FM tuners, especially in tuners equipped with stereo multiplex decoders, is more complex than that in AM radios. Also, reception problems are greater, and customers seemingly are more particular, since they have come to recognize FM as a high-fidelity, static-free method of broadcasting.

In the following paragraphs are briefly described some of the techniques for checking out stereo FM tuners that I have found useful over the years. Those described first require little or no test equipment. Techniques for checking the same parameters but which require more sophisticated test equipment are outlined later.

Important Test Specifications

Before you can accurately measure the performance of an FM tuner, you must have a clear understanding of the major specifications which define an FM tuner's performance. In the case of monophonic

FM tuners, five major and half a dozen minor, or less important, specifications tell the performance story. The major "specs" are:

- 1) IHF sensitivity
- 2) Signal-to-noise ratio
- 3) Harmonic distortion
- 4) Drift
- 5) Frequency response

Less important "specs" include:

- 6) Capture ratio
- 7) Selectivity
- 8) Spurious responses
- 9) IM distortion
- 10) Audio hum
- 11) AM suppression

We shall deal, primarily, with the first five of these "specs".

In addition to being able to check the performance of a tuner with respect to these specifications, a service technician should be able to align and calibrate a tuner, both RF and IF sections; adjust the AFC (automatic frequency control), if such adjustment is provided for; adjust any interstation muting circuitry; and, in the case of stereophonic FM tuners (which now are probably in the majority), measure

such additional parameters as:

- 12) Stereo separation
- 13) Stereo sensitivity
- 14) Sub-carrier rejection
- 15) SCA rejection

Tests Performed Without Test Equipment

While a quantitative sensitivity analysis cannot be performed properly without test equipment, some idea of sensitivity can be obtained by comparison analysis with sets known to be in working order—or, better still, whose sensitivity figures are known—or by analysis of the customer's description of the trouble symptom(s), particularly how quickly and how much the performance changed.

FM quieting characteristics are unlike AM signal-to-noise characteristics, as can be seen in Fig. 1. As the signal strength at the antenna terminals increases, two things happen first: the audio output level increases and the noise decreases. Very soon, however, a point is reached beyond which a further increase in signal strength results in no further increase in audio level but does cause further reduction of

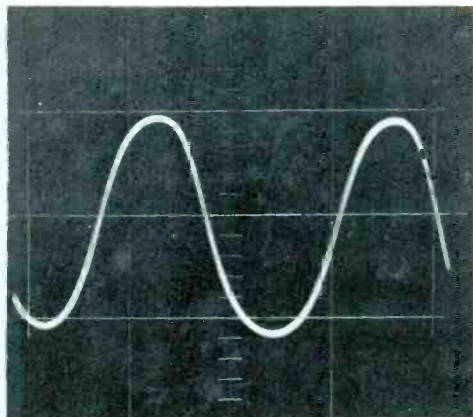

Fig. 2 Waveform amplitude produced by scope which was calibrated so that 75-KHz RF deviation (using a 400-Hz audio tone) produced full vertical deflection of the scope beam.

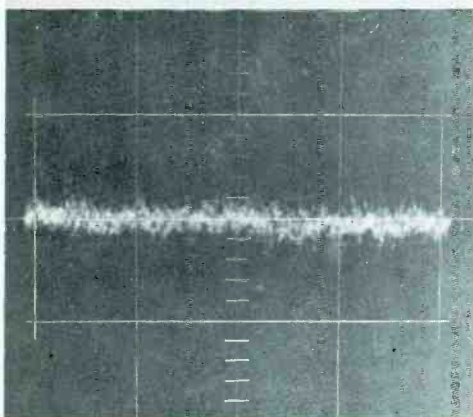

Fig. 3 Amplitude of residual noise, in the absence of modulation, can be compared to maximum audio level of Fig. 1, to approximate signal-to-noise performance of a received program.

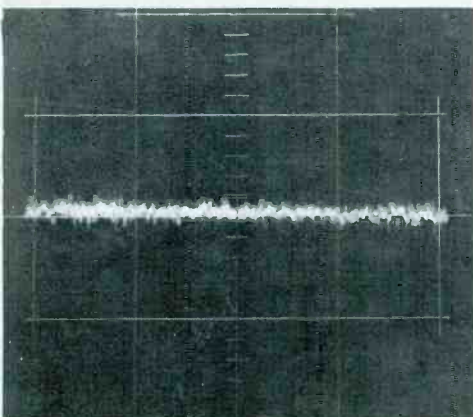

Fig. 4 Stronger RF input signal produces greater noise rejection.

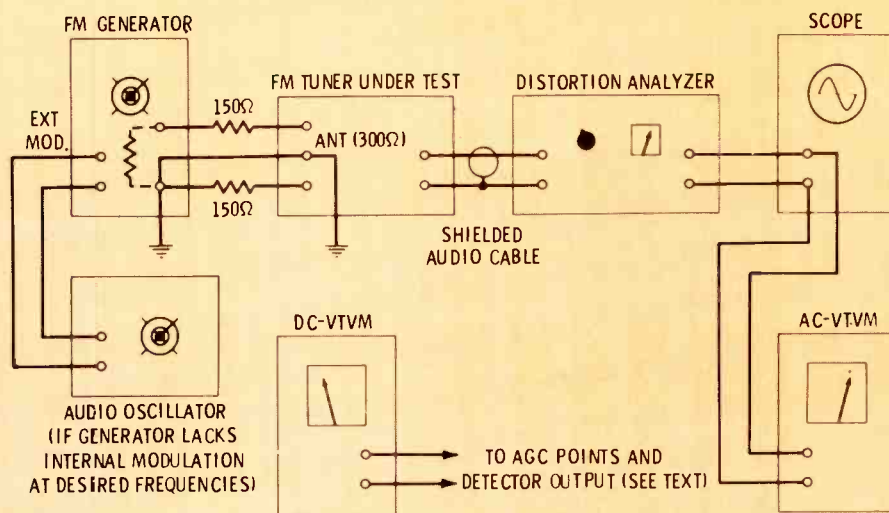

Fig. 5 Proper test setup for making FM tuner performance measurements.

residual noise. This point is known as "full limiting". By tuning across the FM band, and allowing for differences in program material, the experienced technician, simply by listening for large differences in audio level from station to station, can easily tell if most stations are causing "full limiting" in the IF circuits. Better sets will reach full limiting at an input signal of just a few microvolts. Less-expensive sets often require hundreds of microvolts to reach this "plateau".

Short of a defective IF amplifying stage or a totally misaligned RF or IF section, there is little that can cause a set to limit poorly, assuming that it was operating correctly in the first place. Consequently, in many cases, the trouble will be found external to the receiver. For example, the two conductors of the antenna lead-in could have been shorted together by the housewife in the course of dusting behind the set. Or, the antenna could have been disconnected from its transmission line, or the outdoor antenna could have been damaged or broken in a storm. (In a recent study, we found that a moderately sensitive tuner connected to an outdoor antenna exhibited better sensitivity and quieting than did a higher-priced tuner equipped with a 300-ohm indoor "twin-lead" dipole antenna, tossed casually on the floor behind the set.)

At least an elementary idea of sensitivity and quieting can be obtained from off-the-air measurements, using just an oscilloscope and an AC VTVM. Simply connect both of these instruments to the output of the tuner and tune to a desired station, preferably one broadcasting "voice". Set the vertical gain control of the scope so that the peaks of audio modulation just about fill the screen. In Fig. 2 we have approximated this setting using a sine wave produced by a signal generator so that we could photograph a stationary image, but the same instantaneous peak amplitude can be set up on your scope, using random modulation from program material. Next, observe the amplitude of the residual noise on the scope during moments of silence, or absence of modulation. Such residual noise is shown in Figs. 3 and 4. Notice that in Fig. 3 the noise is substantial compared with the previous peaks of modulation, whereas in Fig. 4 the noise level is noticeably lower.

I purposely did not change the vertical gain setting of my scope, to make it perfectly clear what we are trying to show, but once you get the idea, you can readily increase the vertical gain of your scope by fixed amounts (my scope has 10:1 steps, equal to about 20 dB per step). Thus, if you had to shift the vertical gain setting two switch posi-

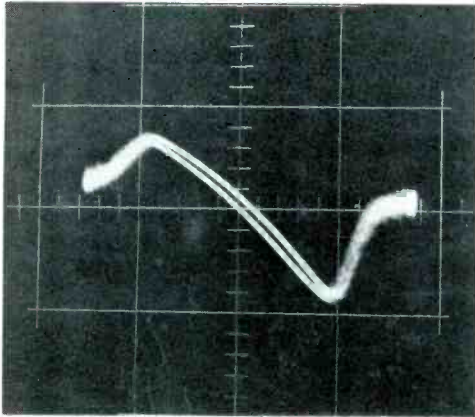

Fig. 6 Typical "S" curve observed at tuner output, using audio modulation to "sweep" FM generator carrier frequency.

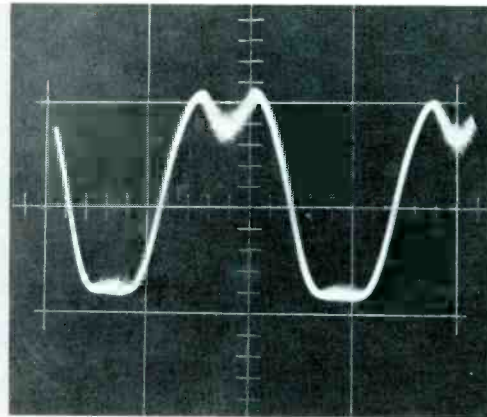

Fig. 7 Narrow bandwidth of tuner IF system produced distorted output waveform shown here.

tions to make the noise amplitude appear as great as the former modulation, you would know the noise is 40 dB lower than full modulation. In other words, this would represent a signal-to-noise ratio of 40 dB. Of course, in the absence of a field-strength meter or a good signal generator, you cannot establish the strength of the signal in microvolts to produce an exact signal-to-noise ratio, but you can, at least, make relative measurements from one set to another, or from one station to another, and in that way establish what represents "good" performance in your area with a given antenna installation.

By observing the modulation of a noise-free station and comparing it with that of a somewhat noisier station, you can approximate the ability of the set to go into "full limiting", even with a relatively weak signal applied, because the audio amplitude will be the same, even though the noise content might be considerably different. Again, remember, in the absence of proper test equipment, the results can be measured only in a qualitative rather than a quantitative sense.

Dial Calibration

Accurate dial calibration can be accomplished without the aid of test equipment, because, in all probability, the accuracy of even the best of signal generators will be poorer than the frequency accuracy of a broadcasting FM station, whose fre-

quency deviation limits are set by the Federal Communications Commission (FCC). First, make certain that the dial pointer itself has not "slipped" on the dial string. If calibration is to be attempted after restringing, follow the manufacturer's instructions for setting the pointer with the rotor of the variable tuning capacitor fully closed. Usually, this will be at the lowest mark on the scale, or at some extra mark or numeral indication provided for just that purpose. Cement the pointer in place on the string, using glyptal or nail polish, after first crimping the pointer onto the new string.

Next, tune in a known station at the low-frequency end of the dial (preferably at about 90 MHz) and wait for positive identification of the station by its call letters, if your FM dial is "crowded". If there is a discrepancy between the station's frequency and the dial setting, carefully tune the local oscillator coil, increasing the coil inductance to lower the frequency, if the station is tuned too low on the dial, or decreasing the coil inductance, if the station is too high on the dial. If more than a small amount of correction is necessary, you also will have to retune any antenna and RF coils located in the front end. If the set has an AGC circuit, this retuning can be accomplished best by tuning for maximum AGC voltage, using a DC VTVM as the readout device. In those sets with no AGC test point or no AGC circuit, I

have found that by disconnecting the antenna, or using a minimal antenna, such as a short piece of wire, the signal can be attenuated to where it is noisy and well below limiting. With the signal thus attenuated, I then carefully "tune by ear" (contrary to all textbook admonitions) in much the same way that I have been "peaking up" AM radios for years. I tune for the loudest and the least noisy reception. I repeat these tests at a high frequency (around 106 MHz, if possible), adjusting the oscillator trimmer, and antenna and RF trimmers, as required, to re-establish correct "high end" calibration. With a little experience, you will find it almost as easy to align the front end of an FM tuner using this method as it is with a signal generator.

IF Alignment

Alignment of the IF section of an FM tuner without test equipment is a bit trickier, because the setting that produces maximum signal is not always the optimum setting. Many manufacturers prefer some form of stagger tuning, to provide better bandpass in their IF chain. In addition, in the absence of an accurate 10.7-MHz signal source, off-the-air IF alignment attempts can result in detuning of the IF circuits to some other center frequency, such as 10.8 MHz or 10.6 MHz, at which frequencies the Q's of the interstage transformers might be lower, resulting in poorer overall gain, limiting

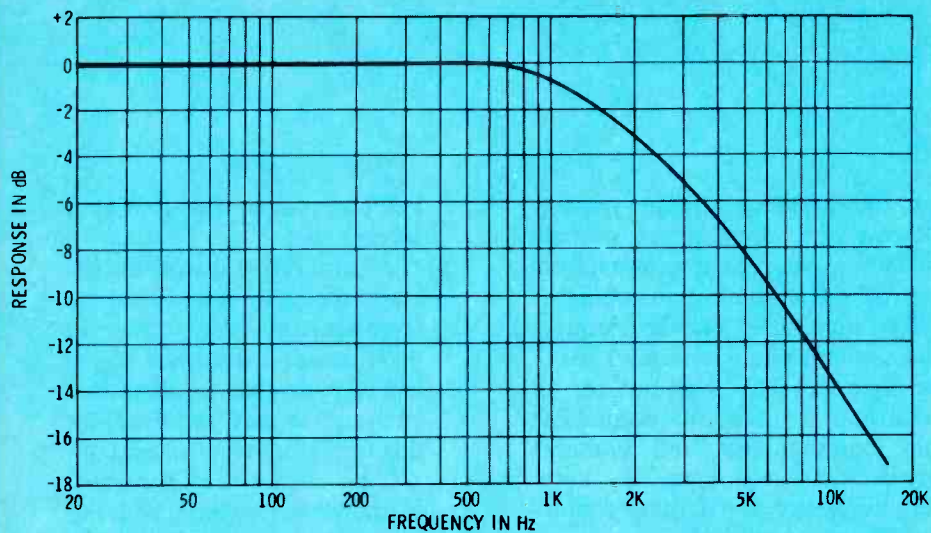

Fig. 8 Correct frequency response characteristic of an FM tuner, if no pre-emphasis is applied to modulating frequencies.

and quieting.

Often, however, noticeable distortion is caused by misalignment of only the detector stage of the IF system. Most FM receivers use a ratio type of detector, the secondary of which can be accurately returned with just the aid of a DC VTVM. To accomplish this, first find the point in the detector circuitry from which the audio (or, in the case of stereo sets, the stereo decoder) circuitry input is obtained, but ahead of any DC isolating coupling capacitors. Connect your VTVM to that point. If possible, set the scale of the VTVM to zero center and use the lowest range. Then, tune in a fairly strong station, tuning for maximum AGC reading or maximum indication on the peak-reading tuning meter, if the set is equipped with one. If, at that tuned point, the DC VTVM connected to the detector indicates anything but zero, tune the secondary slug of the ratio detector until the meter reads exactly zero. Distortion should then be minimum, and the detector tuned exactly to the "center of channel". Correcting a faulty detector circuit in this way also will serve to "balance" any AFC circuits, so that a station will be "pulled in" uniformly from either above or below the desired frequency. Failure of the AFC circuits to perform in this manner is another clue to detector misalignment.

Test Equipment— Costly but Necessary

The procedures outlined previously are quick but, at best, produce uncertain results. For more accurate measurements & alignment, other test equipment is needed. A good signal generator for the FM band costs about \$700.00 new, (there are units used in laboratory applications which cost up to \$2,000.00). If you're going to get serious about FM work, sooner or later you'll need one.

The correct hook-up of an FM generator and other equipment needed for making tests and measurements is shown in Fig. 5. The matching network shown in the diagram is necessary to match the usual 50-ohm output of the generator and the 300-ohm input employed in most FM tuners. As a result of its use, however, all microvolt readings of the generator should be divided in **half**. If you intend to measure only limiting, signal-to-noise ratios and frequency response, the harmonic distortion analyzer shown in Fig. 5 is not needed; but if you want to measure both IHF sensitivity and harmonic distortion, you will need this piece of equipment as well.

IHF Sensitivity

This most important of all FM tuner "specs" often is called "least usable sensitivity". It takes into account two factors: noise and distortion. For a signal to be considered listenable, the combination of these two "undesirables" must be

30 dB below the maximum audio output level. The level of input signal, usually measured in microvolts, required to achieve this result is called the **IHF sensitivity**. To determine the IHF sensitivity of a tuner:

- 1) Set the modulation on the generator to either 400 or 1000 Hz, and adjust for 100 percent (75-KHz) deviation. Either internal or external (using an audio generator) modulation can be used, depending upon the type of generator.
- 2) Tune the set and the generator to a "quiet" point around the center of the dial, and feed into the tuner's antenna terminals a signal of about 10 or 15 microvolts. (Remember, this requires a 20- or 30-microvolt signal out of the generator, because of the matching attenuating network).
- 3) Tune the set to produce the cleanest and largest audio signal, as observed on the scope.
- 4) "Null out" the signal by means of the distortion analyzer, reading the harmonic distortion **plus** residual noise as a percentage. If the reading is less than 3 percent you have exceeded the number of microvolts recommended for an IHF sensitivity measurement. If the reading is more than 3 percent, more signal strength is required to reach the level required for IHF sensitivity measurement. Vary the level of the input signal accordingly, until the "nulled" reading on the distortion analyzer equals exactly 3 percent. The number of microvolts then applied to the antenna terminals of the set equals the IHF sensitivity, and, of course, the lower the number, the better the sensitivity of the set.

You occasionally might encounter a situation in which the noise has all but disappeared from the observed waveform but a 3-percent reading on the distortion analyzer still has not been achieved. In such cases, distortion usually is the culprit, and is caused by insufficient

bandwidth. The scope photo of Fig. 6 shows a typical "S"-curve, obtained at the audio output of a tuner. You can duplicate this waveform by: 1) applying the audio modulation of your generator to the horizontal input of your scope while the vertical input of the scope remains connected to the tuner output, and 2) increasing the deviation beyond the 75-KHz point previously mentioned. The linear portion of the "S"-curve should extend only about 50 KHz above and below the vertical axis. With 75 KHz of deviation applied, the top and bottom of the resulting sinewave at the output will be quite distorted, as shown in Fig. 7. If this condition exists, an increase in signal strength, by itself, will not produce the conditions suitable for IHF sensitivity. Usually, such distortion is caused by severe misalignment or the sudden presence of regeneration (for example, caused by an open bypass capacitor in the IF strip), which constricts, or reduces, the normal bandwidth of these circuits.

Limiting

Using the same test set-up illustrated in Fig. 5, it is easy to determine the point at which "full" limit-

ing takes place. Simply slowly increase the input signal strength while observing the scope waveform and the meter indication, until the audio amplitude of the receiver audio output signal is within 1 dB of its highest value. The number of microvolts required to accomplish this represent the "full limiting" signal. Again, the lower the number, the better the limiting characteristics of a given set.

"Ultimate"

Signal-To-Noise Ratio

The signal-to-noise ratio of a given tuner typically should increase (noise level becomes less, relative to signal level) as the level of the input signal is increased. To determine whether or not a particular tuner's performance meets this expectation, a signal-to-noise test is performed with the input signal level increased to 1000 microvolts (2000 microvolts out of the generator). The result is called the "ultimate" signal-to-noise ratio.

To determine the ultimate signal-to-noise ratio of the tuner:

- 1) Increase the signal input to 1000 microvolts, with full modulation applied.
- 2) Read the resultant audio amplitude on your AC VTVM,

and observe the signal on your scope.

- 3) Now turn off or disconnect the audio modulation and read the (remaining) noise, hum, or whatever extraneous signal is left. Note that the distortion analyzer is **not** required for this test. Usually, what remains will be mostly hum generated in the power supply, and this reading is expressed as the number of dB below full output. Exceptional FM tuners might have a signal-to-noise ratio of 60, 65, or even 70 dB. A signal-to-noise ratio below that established as normal by the manufacturer usually can be traced to excessive hum, itself usually caused by a defective component in the power supply, such as a filter capacitor.

Frequency Response

By applying to your FM generator a series of test modulation frequencies from 50 Hz to 15,000 Hz, at an RF signal input of about 1000 microvolts, and at a constant 75-KHz deviation, a plot of frequency response can be made, such as that shown in Fig. 8. Before you gasp

Fig. 9 Test setup for making stereo separation measurements, using stereo generator having RF input, or using composite audio (dotted lines).

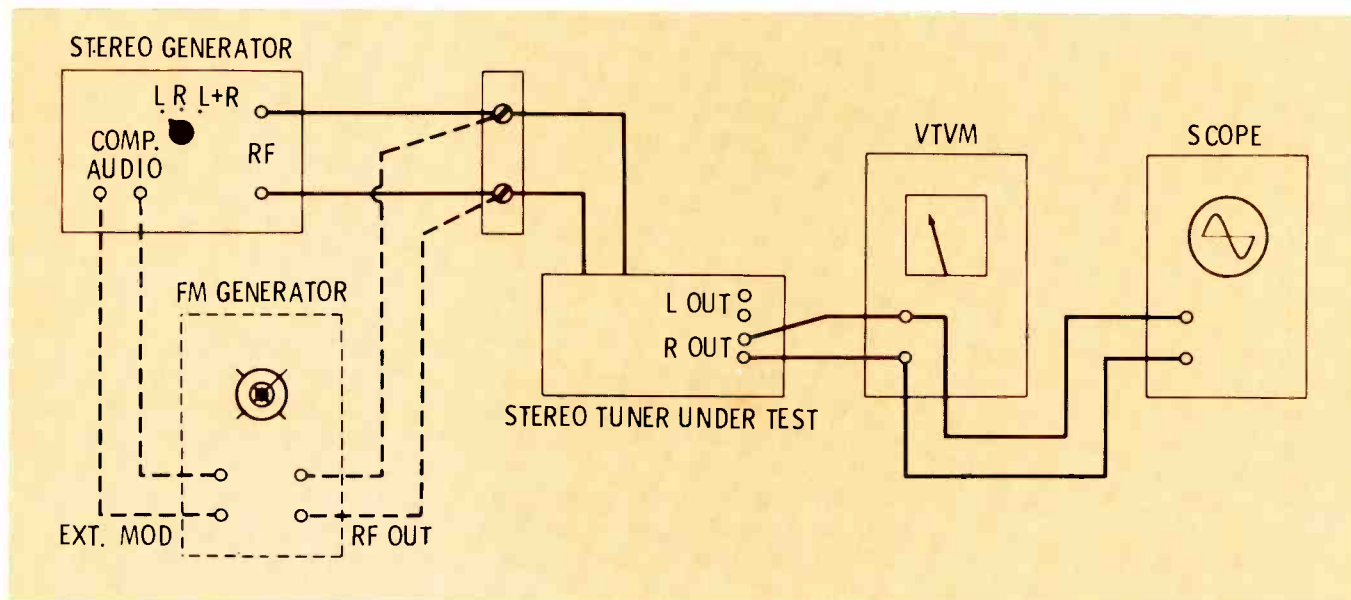

in amazement at the "poor" high frequency response, remember that at the FM transmitter, the high frequencies were deliberately "pre-emphasized" by a prescribed amount, to produce a better signal-to-noise performance. Consequently, at the receiver end it is necessary to de-emphasize the highs correspondingly. Because your generator does not have this built in pre-emphasis, the output results will look like those in Fig. 8, which are entirely normal. In fact, departure from this curve in either direction denotes poor frequency response. If the set does not produce enough de-emphasis of high frequencies, the audio output will sound harsh or shrill.

Harmonic Distortion

Tests of ultimate harmonic distortion are accomplished exactly like the IHF sensitivity checks discussed previously, except that the signal strength at the input to the tuner is increased to 1000 microvolts—theoretically eliminating any noise contribution to the analyzer reading, leaving only the distortion to be read. Be sure to tune exactly to the center of the channel when making this measurement; even slight detuning can increase distortion considerably (a point which should be explained to every owner of an FM set). Readings as low as 1 percent or better are not uncommon with high-quality FM tuners. The lowest I have ever read was about 0.15 percent, but this is quite rare.

Alignment With Instruments

While alignment of RF and IF sections of an FM tuner does not actually fall in the category of "checkout" procedures, the use of proper test equipment for this common servicing procedure cannot be overstressed. After you've invested in a good generator, meters and scope, alignment becomes a routine and simple matter.

Because alignment procedures vary greatly from manufacturer to manufacturer, and even from model to model, only general statements about alignment can be made ac-

curately in this article. IF stages usually are aligned first to 10.7 MHz, using either fixed frequency techniques or sweep alignment methods, depending upon the manufacturers' recommendations. After IF and detector stages have been properly aligned, the RF section is aligned, as previously outlined, using as low an input signal level as is possible. No attempt should be made to evaluate the multiplex stereo decoder circuitry until correct monophonic alignment has been successfully completed, because ultimate stereo performance depends, in part, upon the state of alignment of the monophonic portion of the tuner or receiver.

Separation Measurements

Proper use and understanding of an FM stereo generator or simulator will be dealt with in a forthcoming article in ELECTRONIC SERVICING. For the present, we will assume that your stereo FM generator is properly calibrated and ready for use. If it is equipped with its own RF generator as well as a composite audio output signal, it is better to use the complete generator, measuring total stereo performance of the overall tuner, rather than just de-

coder circuit performance. If your stereo generator has only a composite stereo audio signal output, the best procedure is to apply this signal to the external modulation input of your regular FM generator, as indicated by the dotted lines in the block diagram of Fig. 9. Because you will want to use a strong signal for basic checkout, the matching network shown in earlier diagrams is no longer essential; a slight mismatch of impedance at an input signal strength of 1000 microvolts is meaningless.

The block diagram of Fig. 10 represents a typical stereo decoder circuit. To measure separation:

- 1) Apply a 400-Hz, left-only signal from the stereo generator, so that it provides about 45 KHz of deviation to the RF carrier.
- 2) Be certain the deviation of the 19-KHz pilot carrier signal is set to the correct amount—about 6 to 7 KHz.
- 3) While tuning the set to produce the most and least distorted sine-wave output, read the resultant audio output on a scope and an AC VTVM connected to the left output of the decoder.

Fig. 10 Block diagram of typical stereo decoder circuit, showing adjustments and test points.

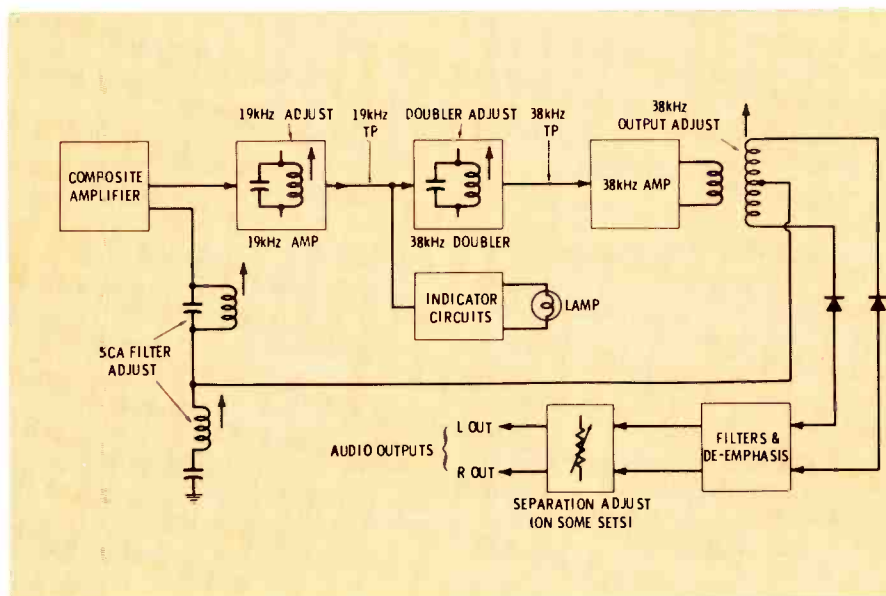

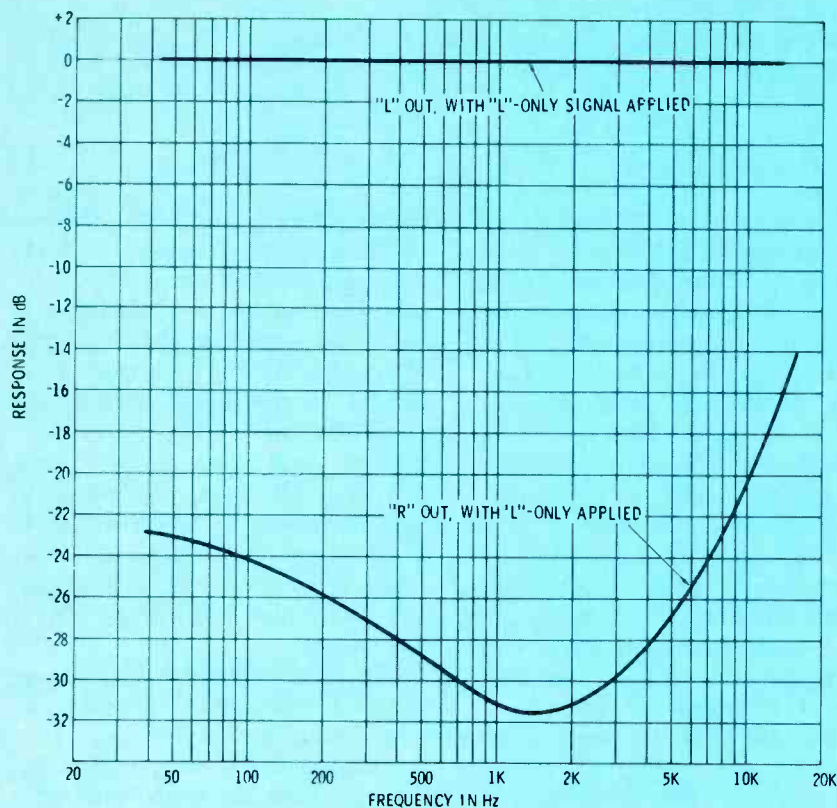

Fig. 11 Plot of stereo separation characteristics of a typical good-quality stereo decoder circuit.

- 4) Switch the stereo generator to a right-only signal and note the drop in output amplitude at the left output of the decoder circuit. If this reading is greater than 30 dB, the stereo tuner has very good separation. More-typical figures for low-to-medium-quality sets generally run from 30 to about 20 dB at midband frequencies.
- 5) Repeat the procedure, this time applying a right-only signal and reading, first, the right output of the decoder for a reference, and then switching to a left-only signal while continuing to read the right-only output point. The two readings should be within 2 or 3 dB of each other.

Decoder Adjustments

Although the actual locations of adjustments vary from design to design, those shown in Fig. 10 represent the typical alignment points in this type of circuit. To peak these adjustments:

- 1) Start with the point electrically nearest the composite amplifier output, the 19-KHz adjustment. Adjust it to produce maximum 19-KHz signal, with

only the pilot carrier used to modulate the RF generator. You can either monitor the amplitude of the 19 KHz at the test point shown, or, if a stereo beacon, or indicator light, is provided in the circuit, adjust for brightest indication of this light, "rocking" the slug back and forth to locate the optimum point.

- 2) The 38-KHz doubler tuned circuit then is adjusted either for maximum indication of the light (if it is located beyond that point in the circuit) or by direct visual indication on the scope and meter.
- 3) Adjust the 38-KHz detector transformer while observing the separation, as previously mentioned.
- 4) Finally, if there is a resistive separation adjustment (not present in all circuits), it should be adjusted for optimum separation. For example, often it is possible to improve the separation of the left channel, only to discover the separation has been somewhat degraded on the opposite channel. In my opinion, it is better to "compromise" the setting of the sep-

aration adjustment to produce equal separation on both channels, rather than superior separation on one and less separation on the other. It, therefore, is a good idea to check the opposite channel after all the adjustments in the other channel have been made, to make sure that no deterioration of the opposite-channel separation has been introduced.

A checkout of high-frequency separation is also recommended, because separation at high frequencies is often much poorer than at mid-band frequencies. A typical plot of separation vs frequency of a good-quality decoder circuit is shown in Fig. 11.

SCA Rejection Filters

Most modern stereo decoders are equipped with passive filters designed to attenuate the 67-KHz signal broadcast by stations who provide "background music" (SCA) services. If they are not attenuated by the receiver, these SCA signals can cause a "swooshing" or whistling sound in the recovered stereo program. A simple two- or three-element filter usually is sufficient to remove this interference at an early point in the decoder circuits.

To properly tune the SCA-rejection filter:

- 1) Apply a 67-KHz signal, with about 10-percent modulation, to your generator.
- 2) While monitoring the 67-KHz output at the SCA test point shown in the block diagram of Fig. 10, adjust the SCA filter circuits for a "null". That's all there is to it.

Conclusion

FM receivers and tuners are more complex pieces of equipment than their AM predecessors. The addition of multiplex stereo decoder circuitry further increases this complexity. An understanding of related specifications and methods of measuring them, as outlined above, will enable you to perform stereo FM servicing as confidently and competently as you do TV and AM servicing. ▲

bookreview

Transistor Audio Amplifiers

(Catalog No. 20838)

Author: Jack Darr

Publisher: Howard W. Sams & Co., Inc.

Size: 5 3/8 x 8 1/2 inches, 192 pages

Price: Softcover, \$5.50.

Written by a technician for other technicians, this text covers all knowledge and skill areas essential to the efficient troubleshooting of solid-state audio amplifiers. These areas include: recognition of normal and abnormal circuit conditions; effective troubleshooting techniques, including when and where to apply what test instrument; and how to select and install replacements.

Contents: Transistors: Characteristics, Typical Circuits—Drivers and Output Stages—Power Supplies—Test Instruments and Test Methods—Very Small Amplifiers—Medium-Powered Amplifiers—Medium- To High-Power Types—Very High-Power Amplifiers—Replacing Small-Signal Transistors—Power-Output Transistors.

Color TV Servicing

Author: Walter H. Buchsbaum

Publisher: Prentice-Hall, Inc.

Size: 6 1/4 inches x 9 1/4 inches, 272 pages

Price: Hardcover, \$9.95.

A comprehensive textbook which explains fundamental principles of colorimetry, circuit functions and theory of operation, installation problems and procedures, alignment and adjustment procedures, common trouble symptoms and causes and general and specific troubleshooting techniques. Well illustrated, including four-color photos of trouble symptoms, normal color patterns and color diagrams, plus simplified schematic and block diagrams.

Contents: Introduction to Color TV—Principles of Colorimetry—Color TV Signals

—A Color TV System—Color Picture Tubes—Color Picture Tube Circuits—A Typical Color TV Receiver—Antenna, Tuner and IF Section—The Color Decoder—Color Sync—Deflection and Special Color Circuits—Installation—RF-IF Alignment—Color Decoder Adjustment—Sync and CRT Color Adjustments—Troubleshooting Monochrome Operation—"No Color" Defects—"Wrong Color" Defects—General Troubleshooting Procedures.

How To Use Vectorscopes, Oscilloscopes and Sweep-Signal Generators (Book No. 550)

Author: Stanton R. Prentiss

Publisher: TAB Books

Size: 5 3/4 inches x 8 5/8 inches, 256 pages

Price: Hardbound, \$7.95; soft cover, \$4.95.

Troubleshooting and alignment applications of oscilloscopes and interpretation of scope displays are emphasized in this text. Included are both fundamental and advanced techniques for using recurrent- and triggered-sweep scopes. Descriptions of the internal circuitry of the test instruments discussed in this text are limited to block diagram analysis, and are included only where absolutely essential to the understanding of the application or the interpretation of the displayed waveform.

Contents: General Analysis of Oscilloscopes — Vectorscopes — Basic Uses For An Oscilloscope—Sampling Storage and Spectrum Analyzer Scopes—Sine, Square and Triangular Waves—Pushbutton Alignment and Sweep Generators—Vectorscope Troubleshooting and Chroma Alignment—Finding Bad Components With A Scope—IC and Transistor Circuit Troubleshooting—Stereo Multiplex Troubleshooting With A Vectorscope.

COLOR TV CONTROLS



FOR
AUDIO
FOCUS
COLOR
SENSITIVITY
BRIGHTNESS
HORIZ. FREQ.
A.G.C. DELAY
CONVERGENCE
VERT. CENTER
HORIZ. CENTER
VERT. LINEARITY

105 EXACT REPLACEMENTS

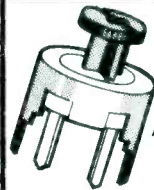

RCA · ZENITH
SILVERTONE
ADMIRAL Etc.

ASK FOR FREE CROSS
REFERENCE No. X67

MANUFACTURED FOR THE OEM
MARKET. NOW AVAILABLE FOR
REPLACEMENT PARTS

WORKMAN *Electronic*
PRODUCTS, INC.
P.O. BOX 3828 SARASOTA, FLORIDA 33578

Circle 29 on literature card

TV TECH SPECIALS

90 Degree Color Yoke
Repl. Y 109-DY95 AC \$8.95
20 Assorted Controls \$3.95
10 1N34A Diodes \$1.00
20-1 Amp. 1000 PIV (Epoxy)... \$3.95
20-2 Amp. 1000 PIV (Epoxy)... \$4.95
6500 PIV Focus Rect.... 3 for \$2.00

RCA COND. AXIAL LEADS

50 Mfd. 50 V 4 for \$1.00
500 Mfd. 50 V 4 for \$1.89
1000 Mfd. 50 V 4 for \$2.50
40 Mfd. 150 V 4 for \$1.29
80 Mfd. 150 V 4 for \$1.89
100 Mfd. 250 Volts 4 for \$1.98
2 Mfd. 450 V 6 for \$1.49
4 Mfd. 450 V 6 for \$1.69
10 Mfd. 450 V 6 for \$1.98
16 Mfd. 450 V 6 for \$2.29
30 Mfd. 450 V 6 for \$2.98
10 Mfd. 600 V 4 for \$2.29
20 Mfd. 600 V 4 for \$2.69

RCA COND. CANS

50-30 Mfd. 150 V 3 for \$1.29
300 Mfd. 150 V 2 for \$1.59
125 Mfd. 350 V 3 for \$1.98
80 Mfd. 450 V 4 for \$2.39

SEND FOR FREE CATALOG

Tubes Up To 80% Off
Minimum Order \$15.00
Send Check or M.O.

TV TECH SPECIALS

P.O. Box 603
Kings Park, L.I., New York 11754

Circle 30 on literature card

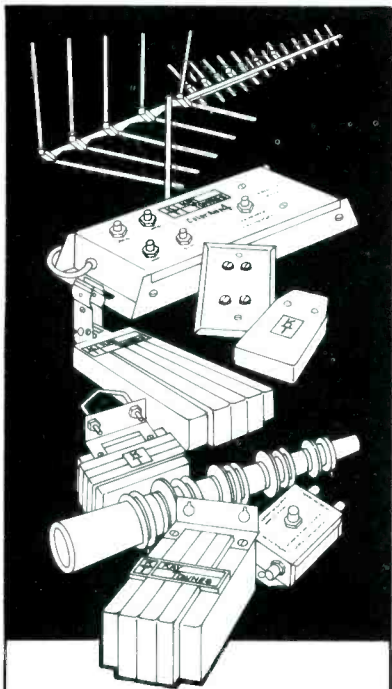

From Antennas to Wall Outlets **KAY-TOWNES** Makes Everything!

One supplier, one distributor can give you a complete line of high quality systems and components for better TV pictures and brighter sales pictures!

You can sell a complete line of

- All-Channel TV and FM Antennas
- Area Special Antennas for your location
- Hi-Carbon Golden Masts... telescoping or straight lengths
- Distribution Amplifiers and Systems
- Antenna Mounted Amplifiers and Couplers
- All related equipment including: Splitters, Couplers, Mixers, Wall-Taps and Drop-Taps.

Every Kay-Townes product is field tested, performance proved... and designed and manufactured in the U.S.A.

**WRITE NOW FOR OUR
COMPLETELY NEW
MATV AND ANTENNA
CATALOGS!**

KAY-TOWNES

P.O. Box 593
Rome, Georgia 30161
Phone: (404) 235-0141

Circle 31 on literature card

productreport

for further information on any of the following items, circle the associated number on the reader service card.

Audiovisual Service Training Programs

Three new audiovisual information programs designed to furnish practical servicing guidelines and solutions to technicians are now available from RCA distributors.

Prepared by RCA Commercial Engineering, the new technical training aids cover specific areas of servicing. Each program reportedly consists of a series of color-slide presentations with professional graphics and illustrations, an audibly synchronized cassette tape recording and a brochure recapping the main points for maximum effectiveness. A Kodak "Carousel" 35-mm projector and a standard cassette tape recorder are required for group or individual presentation.

The first tape-cassette/slide-film presentation is titled "Color TV Picture Tube Installation and Associated Receiver Adjustments" (No. 1D144). It offers specifics on color picture tube replacement; outlines safety precautions; indicates short cuts for tube removal and replacement; and provides step-by-step guidelines for performing



convergence, purity, and tracking adjustments—intermixed with electronic theory, for greater understanding of TV electronics, according to RCA. The list price for this 43-minute presentation is \$69.95 each.

The second audiovisual aid, keyed to RCA's replacement solid-state devices, is titled "Part I—Basic Techniques for Transistor Checking" (No. 1L1337). It explains the use of basic types of test equip-

ment; provides simple techniques for transistor checking; reveals quick ways to identify unknown transistor leads and types, and offers cost-saving information on good servicing practices, techniques and short cuts, according to RCA. The list price for the 23-minute presentation is \$39.95 each.

The third service aid deals with "no-raster" problems and is titled "Television Servicing—Part I: No-Raster Condition" (No. 1A1853). This presentation is keyed to an RCA tube replacement "road chart" and provides a preliminary check list and a diagram outlining procedures recommended by RCA television specialists. Both "no raster-no sound" and "no raster-sound present" conditions are discussed. Time-saving servicing techniques reportedly are also included. The list price for this 18-minute presentation is \$39.95 each.

Circle 80 on literature card

Ceramic Capacitors

An assortment of 795 Cera-mite® disc ceramic capacitors specially selected for use by technicians in service/dealer organizations has been announced by the Sprague Products Company.



The J-150 "Ceramiccenter" ceramic assortment reportedly offers easy selection of 78 different capacitance and voltage ratings in general application types, high-K types, temperature-stable types, and ultra-miniature units for transistorized circuits.

The J-150 is housed in a heavy-gage two-drawer steel cabinet, measuring 30¾ inches x 11½ inches x 5½ inches.

The capacitors included in the cabinet are packaged in plastic Klear-Paks® placed in compartmented drawers outfitted with pre-printed index cards.

The J-150 "Ceramiccenter" sells for \$184.25.

Circle 81 on literature card

Carbide Shear Cutter

A production plier with shear-cut carbide jaws and a special blade configuration which allows an .040-inch lead stand-off to remain after the lead has been cut is announced by Techni-Tool, Inc.

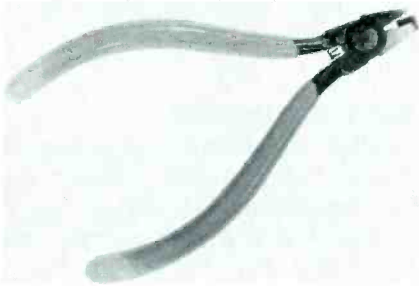

This stand-off is sometimes desired for wave solder operations. The cut is reportedly made square and burr free without shock to any delicate component leads.

The plier has cushioned grips and return springs for operator comfort and sells for \$9.50.

Circle 82 on literature card

Color "Gun Control"

Single-Brite, Model B-150, permits the restoration of color picture balance when a single color gun weakens prematurely, according to the manufacturer, Chamberlain Mfg. Corp.

The new potentiometric device reportedly lets the technician adjust the bias between the G1 and G2 grid leads of the weakened gun, permitting color intensity variation as needed for a balanced picture.

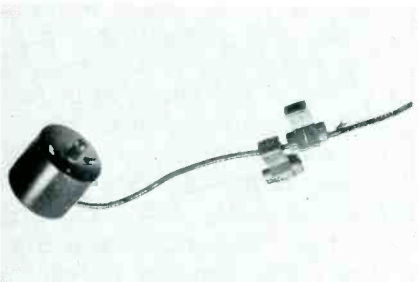

Tube filament voltage is not increased by the use of the Single-Brite, reports the manufacturer.

Installation reportedly requires only two connections and no soldering.

Model B-150 sells for \$8.00.

Circle 83 on literature card

advertisers' index

American Telephone & Telegraph Co.	1
B & K Manufacturing Co.	53
Bussmann Mfg. Div. McGraw-Edison Co.	9
Chemtronics Inc.	39
Eico Electronic Instrument Co., Inc.	6
Enterprise Development Corp. ...	63
General Electric Company Television Business Division ...	19
General Electric Co. Receiving Tube Dept. ...	17, Cover 2
Heath Company	41
Jerrold Electronics Corp.	36
Kay Townes Antenna Company ...	62
Lectrotech, Inc.	14
Littelfuse, Inc.	Cover 4
Precision Tuner Service	15
RCA Parts and Accessories	13
RCA Electronic Components	Cover 3, 21
RCA Sales Corporation	38
RMS Electronics Inc.	16
Howard W. Sams & Co., Inc. ...	10-11
Sprague Products Company	3
Sylvania Electric Products Inc. ...	7
TV Tech Aid	52
TV Tech Specials	61
Tuner Service Corporation	5
Workman Electronic Products, Inc.	14, 61
Xcelite, Inc.	37
Yeats Appliance Dolly Sales Co. ...	63

ELECTRONIC SERVICING

is your magazine!

If you would like to see an article about a particular subject directly related to servicing consumer or communications electronic products, send us your suggestion.

We value your comments and criticism.—Ed.

YEATS
handles SHORT or TALL appliances with non-slip grip!

MOST VERSATILE APPLIANCE TRUCK DEVELOPED!

FREE illustrated brochure
YEATS Model No. 5 \$66.50

YEATS APPLIANCE DOLLY SALES CO.
1300 W. FOND DU LAC AVE.
MILWAUKEE, WIS. 53205

Circle 32 on literature card

Unsolder it with the Endeco 300

Pencil Desoldering Iron

MODEL 300

ENTERPRISE DEVELOPMENT CORPORATION INDIANAPOLIS

Removes miniature soldered components in seconds—without damage

Hollow tip fits over connection; vacuums all solder for easy removal of component. Leaves terminals and mounting holes clean. Then, with 360° contact, it resolders faster, better than regular irons. Handles miniature and standard components in PC boards and conventional wiring. Self-cleaning. All parts replaceable. 40 watts, 120-v. Standard tip supplied, 5 other tip sizes available. Pays for itself. \$11.95 net East of the Rockies.

Larger model available. See your distributor or write:

ENTERPRISE DEVELOPMENT CORPORATION
5127 E. 65th St. • Indianapolis, Ind. 46220

Circle 33 on literature card

ANTENNAS

100. *Jerrold Electronics Corp.*—has released a 56-page full line general distributor catalog which includes a guide to MATV systems and nearly 300 Jerrold products. The catalog cost is \$1.00.*
101. *Jerrold Electronics Corp.*—Catalog S, titled "Systems and Products for TV Distribution," lists specifications of this manufacturer's complete line of antenna distribution products, including antennas and accessories, head-end equipment distribution equipment and components, and installation aids.*
102. *Russell Industries*—announces the availability of a complete line of telescoping antenna rods with swivel bases and sliding adapters for rods to disappear. This line is recommended for walkie/talkie and all portable radio applications.
103. *Vikoa, Inc.*—is making available a 64-page, illustrated catalog covering their line of wire and cables and IDS/MATV equipment. Hardware, accessories, connectors, fittings and an index also are included.*
104. *Winegard Antenna Systems*—has made available a 32-page catalog designated No. 710 which gives specifications and descriptions on their line of outdoor and indoor TV and FM antennas, preamplifiers, wire, home TV systems equipment and commercial systems equipment. Winegard offers a complete selection of solid-state amplifiers, boosters and electronic devices for MATV systems.

AUDIO

105. *Altec Lansing*—introduces a 12-page brochure for in-

formation on sound systems in the sports and entertainment field, stadiums, automobile speedways, hotels, restaurants and other public entertainment facilities.

106. *American Gelo Electron-ics, Inc.*—has published an 8-page brochure on their line of mini-column sound systems and baffles and speakers. Specifications and installation instructions are included.
107. *Bell P/A Products Corp.*—a new 6-page catalog gives detailed specifications and descriptions of the company's broad line of commercial sound components and special purpose sound system products.
108. *Darome, Inc.*—has released an 8-page brochure showing how a complete background music, local public address, and constant level paging system can be installed without using relays or complicated wiring.
109. *Duotone Co.*—has made available a new color replacement needle reference wall chart. The chart covers almost all of the major manufacturers from American Microphone and Audax to Telefunken and Zenith. All categories are grouped according to manufacturer, enabling quick and precise answers.
110. *Jensen Manufacturing Div.*—has issued an 8-page, catalog, No. 1090-E, which describes applications of 167 individual speaker models. Special automotive, communications, intercom and weathermaster speakers, plus a complete line of electronic musical instrument loudspeakers are featured.
111. *Nortronics Co., Inc.*—has released a new Tape Head Replacement Guide which contains tape head replacements for over 2800 domestic and foreign recorder models, and a cross-reference to both model and head part numbers for reel-to-reel and cartridge recorders.

112. *Shure Brothers, Inc.*—has published a 4-page brochure, "Professional Sound Systems in High Schools, Colleges, and Universities," No. AL 398, describes the company's Vocal Master Sound System and how it helps solve public-address problems.

AUTO ELECTRONICS

113. *GC Electronics*—has issued an eight-page, three-color brochure, FR-132 on their new line of car stereo and radio accessories. Included are cartridge radio tuners and burglar alarms.
114. *Littlefuse, Inc.*—has released a new 32-page 1971 automotive replacement fuse guide for passenger autos, sports cars, trucks, and taxi cabs. Fuse descriptions and circuits protected are included.*

CABLE

115. *Belden Corporation*—announces a 60-page catalog, No. 871 featuring 134 new products for the instrumentation, communications and data processing fields. Line drawings show physical configurations of each cable type.

COMMUNICATIONS

116. *The Hallicrafters Co.*—has published a 4-page, two color brochure which provides the complete mechanical and general specifications of the Porta Command PC-230 FM 2-way radio, including the full line of accessories which expand the new radio's versatility.
117. *Sonar Radio Corp.*—Catalog titled "Sonar Business Radio, FM Monitor Receivers and CB Equipment," lists specifications and prices of this manufacturer's line of transceivers, receivers and communications accessories.

COMPONENTS

118. *Alco Electronic Products, Inc.*—introduces their line

- of Subminiature Incandescent Lamps as described in their new Alcolite Catalog, LA-711. Prices and complete specifications are given for Alco's lamps.
119. *Burstein Applebee* — announces a Guide to RCA Industrial Tube Products. The 31-page guide contains two major sections; Characteristics and Replacements.
 120. *General Electric Tube Department* — has released a new 52-page Entertainment Semiconductor Almanac, No. ETRM-4311F. The almanac contains approximately 20,000 cross references from JEDEC, or OEM part numbers to GE parts numbers for universal replacement semiconductors, selenium rectifiers for color TV, dual diodes, and quartz crystals.*
 121. *General Electric* — a 12-page, 4-color, illustrated "Picture Tube Guidebook", brochure No. ETRO-5372, provides a reference source for information about GE color picture tube replacements and tube interchangeability.*
 122. *The Hallicrafters Co.* — is offering a 4-page, two color brochure that features the complete line of CRX "Portamon" special frequency monitor radios, lightweight pocket portable and table model radios.
 123. *Loral Distributor Products* — has made available a 24-page electrolytic capacitor replacement guide. The catalog features replacement products by the original manufacturer's part number.
 124. *Motorola, Inc.* — has made available a HEP cross reference guide catalog No. HMA07 which lists replacements for over 27,000 different semiconductor device type numbers available through authorized HEP suppliers.
 125. *RCA Distributor Products* — is offering an 8-page illustrated pamphlet entitled "When, Where and Why It Pays To Switch To RCA Alkaline Rechargeable Batteries," No. 1P1385.*
 126. *RCA/Solid State Division* — announces a revised edition of the Power Transistor Directory, which reflects new product programs, as well as new product data. All product matrices have been updated to include the latest commercial types as well as preliminary data on developmental types, including RCA power transistors, both silicon and germanium. The Index of Types has been expanded to include DT types as well as JEDEC (2N-Series) types and RCA 40-K series types. Copies are \$.40.*
 127. *Semitronics Corp.* — has a new, revised "Transistor Rectifier, and Diode Interchangeability Guide" containing a list of over 100 basic types of semiconductors that can be used as substitutes for over 12,000 types. Include 25 cents to cover handling and postage.
 128. *Stancor Products* — pocket-size, 108-page "Stancor Color and Monochrome Television Parts Replacement Guide" provides the TV technician with transformer and deflection component part-to-part cross reference replacement data for over 14,000 original parts.
 129. *Sylvania Electric Products, Inc.* — a 73-page guide which provides replacement considerations, specifications and drawings of Sylvania semiconductor devices plus a listing of over 35,000 JEDEC types and manufacturers' part numbers. Copies are \$1.00.*
 130. *Workman Electronic Products, Inc.* — has released a 32-page, pocket-size cross reference listing for color TV controls. 105 Workman part numbers are listed in numerical order with specifications and illustrations of the part.*

MISCELLANEOUS

131. *Electronic Industries Association* — announces the 1971 "Consumer Electronics Annual," describing developments in the consumer electronics industry over the past 51 years. Copies are \$.50 each.

PICTURE TUBES

132. *GTE Sylvania, Inc.* — has published an interchangeability guide listing 191 commonly used color TV picture tubes, which can be replaced with 19 GTE Sylvania Color Bright 85® types.

SERVICE AIDS

133. *Chemtronics, Inc.* — has published a 6-page, 4-color, folder describing TUN-O-BRITE chemical spray. Application uses are included.*

SPECIAL EQUIPMENT

134. *Switchcraft, Inc.* — announces a new catalog containing 25 new product listings and over 400 new individual items. All new listings are clearly marked. The 36-page book covers such major Switchcraft product categories as jacks, plugs, switches, connectors, molded cable assemblies, and audio accessories.

TV ACCESSORIES

135. *Telematic* — introduces a 14-page catalog featuring CRT brighteners and reference charts, a complete line of test jig accessories and a cross reference of color set manufacturers to Telematic Adaptors and convergence loads.

TECHNICAL PUBLICATIONS

136. *Associated Research, Inc.* — announces a 34-page operation and application handbook (Manual 17456) describing the MEG-CHEK,

megohmmeter. Operating instructions, setups and procedures are included.

137. *Howard W. Sams & Co., Inc.*—literature describes popular and informative publications on radio and television servicing, communications, audio, hi-fi and industrial electronics, including their 1970 catalog of technical books about every phase of electronics.*
138. *Sencore, Inc.*—Speed Aligner Workshop Manual, Form No. 576P, provides 20 pages of detailed, step-by-step procedures for operation and application of Sencore Model SM158 Speed Aligner sweep/marker generator.
139. *Sylvania Electric Products, Inc., Sylvania Electronic Components Div.*—has published the 14th edition of their technical manual, which includes mechanical and electrical ratings for receiving tubes, television picture tubes and solid-state devices. Price of this manual is \$190.*

TEST EQUIPMENT

140. *B & K Mfg. Div., Dynascan Corp.*—is making available an illustrated, 24-page 2-color Catalog BK-71, featuring B&K test equipment, with charts, patterns and full descriptive details and specifications included.*
141. *Eico*—has released a 32-page, 1970 catalog which features 12 new products in their test equipment line, plus a 7-page listing of authorized Eico dealers.*
142. *Leader Instruments Corp.*—presents a 20-page catalog detailing more than 50 test instruments and accessories for electronic equipment maintenance, repair and servicing.
143. *Leader Instruments Corp.*—announces the 1971 Catalog of Leader Test Equipment. Test equipment included is the LBO-301 portable triggered-sweep oscilloscope, LSW-330 new solid-

state post injection sweep/marker generator, and the LCG-384 mini-portable, solid-state battery operated color-bar generator.

144. *Leasamatic*—has published a 16-page catalog of "Used Instruments For Sale". Instruments for sale include: Wave Analyzers, Counters, Digital Voltmeters, Impedance and Phase equipment, Oscilloscopes, Signal Sources, Temperature Chambers, Recorders, Voltmeters, Microwave Instruments, Amplifiers, Power Supplies and Microwave Components.
145. *Mercury Electronics Corp.*—14-page catalog provides technical specifications and prices of this manufacturers' line of Mercury and Jackson test equipment, self-service tube testers, testers, test equipment kits and indoor TV antennas.
146. *Pomona Electronics*—has published a 60-page, 1971 catalog of electronic test accessories which contains more than 450 individual products, including 47 new items.
147. *Triplett Corp.*—Bulletin No. 51570, a 2-page technical bulletin which provides the specifications and price of Triplett's new Model 602 VOM.

TOOLS

148. *Brookstone Co.*—introduces a new, expanded 32-page catalog offering hundreds of unusual and extremely useful hard-to-find tools. Among the new tools are: glass pliers, hand vices, glass drills, jewelers' screwdrivers, watchmakers' loupes, and many other hand tools and small power tools.
149. *The Chapman Mfg. Co.*—announces the 1971 catalog of Chapman tool kits. The CMH-3 screwdriver handle, the METRIC socket screw adapter and the BRISTOL spline type adapter are

featured.

150. *General Electric*—has issued a 2-page brochure No. GEA-8927, describing the features of GE's new soldering iron.*
151. *Jensen Tools and Alloys*—has announced a new catalog No. 470, "Tools for Electronic Assembly and Precision Mechanics." The 72-page handbook-size catalog contains over 1,700 individually available items.
152. *Krieger & Dranoff, Inc.*—announces a 176-page catalog of tools and equipment for precision instrument and electronic work.
153. *Xcelite, Inc.*—Bulletin N770 describes this company's three new socket wrench and ratchet screwdriver sets.*
154. *Xcelite, Inc.*—has published a 2-page illustrated Bulletin N670, which introduces two new reversible ratcheting handles for use with more than 60 of the company's available Series "99" nut-driver, screwdriver and special purpose blades.*

*Check "Index to Advertisers" for additional information. ▲

GET COMPLETE DETAILS

about the products
advertised or described
in this issue.

Use Free
Reader Service Card.

Be sure to include
your name and address

Moving?

Send your new address to:
ELECTRONIC SERVICING

Circulation

1014 Wyandotte St.
Kansas City, Missouri 64105

Now, your choice- 1 or 2 year warranty on all RCA color picture tubes



A big business builder for you with the industry's most complete line.

1. RCA offers an extended warranty, for a second year, on all Hi-Lite and Colorama color replacement tubes.

2. The second year is optional. You can still offer the customer RCA's one year warranty. Or for a modest extra charge there's a whole additional year of protection. It's your choice!

3. This extra protection will help you sell many customers on replacing the tube instead of the set.

4. It will keep them coming back to you for service on their TV sets and other equipment.

5. You can sell with extra confidence. There's added protection on the quality name picture tube line designed to enhance your professional reputation.

That's why the RCA extended warranty is your most powerful new sales tool for 1971! Get full details from your local RCA Distributor.

RCA | Electronic Components | Harrison, N.J. 07029

RCA

THE SAFEST SETS YOU'LL EVER SERVICE HAVE LITTELFUSE CIRCUIT BREAKERS.



Standard Catalog Part No.	Hold Rating (Amps.)	Standard Catalog Part No.	Hold Rating (Amps.)
815.650	.490	8-52.75	1.92
815.800	.600	8-5003	2.1
815001	.650	8-53.25	2.2
8151.25	.930	8-5004	2.5
81501.5	1	8-504.5	3
8151.75	1.2	8-5005	3.25
815002	1.4	8-5006	3.9
8152.25	1.5	8-5007	4.14
81502.5	1.65		

Littelfuse TV set circuit breakers are the safe, reliable, money saving short-circuit-problem-solvers . . . 17 available models—exact replacements—cover the entire range of domestic television sets.

Littelfuse circuit breakers are available from your distributor—single or in bulk.

Super-simple in operation—the sensitive breaker flips open under current overloads protecting the circuitry. Reset by merely pressing the red reset plunger. A built-in “trip free” feature of Littelfuse breakers prevents forced closing when dangerous overload currents are present.

Nothing's more reliable than a Littelfuse circuit breaker. Thermal-responsive Littelfuse breakers are dual operated bi-metallic devices providing temperature compensation over a wide range of ambient temperature variation. Molded phenolic construction eliminates warping and distortion of the base, maintaining exact factory set calibrations. The unit is completely enclosed to protect critical moving parts from dirt and other foreign matter.

Any TV set you're likely to service will take Littelfuse circuit breakers.

They'll flip for safety.

You'll flip for satisfaction.

LITTELFUSE

DES PLAINES, ILLINOIS 60016

SUBSIDIARY OF TRACOR, INC.

Circle 3 on literature card